

# Instruction Manual

*G-SERIES Backup Camera System  
with Auto Dimming and OnStar*

RVS-776718-DOS





Introduction. . . . . 03

Safety Information. . . . . 04-06

Before Beginning Installation. . . . . 07

Installation Guide. . . . . 08-09

Adjustable Grid Line. . . . . 10

Installation and Wire. . . . . 11-13

Auto Dimming . . . . . 14-15

Wiring. . . . . 16-17

Monitor Specifications. . . . . 18

Camera Specifications. . . . . 19

Camera Installation. . . . . 20

Troubleshooting. . . . . 21

Warranty & Disclaimer. . . . . 22-23

**NOTE!**

***Please read all of the installation instructions carefully before installing the product. Improper installation will void manufacturer's warranty.***

***Congratulations*** on purchasing a Rear View Backup Camera System!

With this manual you will be able to properly install and operate the unit.

The Backup Camera System is intended to be installed as a supplement aid to your standard rear view mirror that already exists in your vehicle. The Backup Camera System should not be used as a substitute for the standard rear view mirror or for any other mirror that exists in your vehicle.

In some jurisdictions, it is unlawful for a person to drive a motor vehicle equipped with a TV viewer or screen located forward of the back of the driver's seat or in any location that is visible, directly or indirectly, to the driver while operating the vehicle.

Please read the entire manual and follow the instructions and warnings carefully. Failure to do so can cause serious damage and/or injury, including loss of life. Be sure to obey all applicable local traffic and motor vehicle regulations as it pertains to this product. Improper installation will void manufacturer's warranty.

## **USAGE:**

- The Rear View Camera System is designed to help the driver safely detect people and/or objects helping to avoid damage or injury. However, you the driver, must use it properly. Use of this system is not a substitute for safe, proper or legal driving.
- Never back up while looking at the monitor alone. You should always check behind and around the vehicle when backing up, in the same way as you would if the vehicle did not have the Rear View Camera System. If you back up while looking only at the monitor, you may cause damage or injury. Always back up slowly.
- The Rear View Camera System is not intended for use during extensive back-up maneuvers or backing into cross traffic or pedestrian walkways.
- Please, always remember, the area displayed by the Rear View Camera System is limited. It does not display the entire panorama that is behind you.

## **INSTALLATION:**

- Electric shock or product malfunction may occur if this product is installed incorrectly.
- Use this product within the voltage range specified. Failure to do so can cause electronic shock or product malfunction.
- Take special care when cleaning the monitor.
- Make sure to firmly affix the product before use.
- If smoke or a burning smell is detected, disconnect the system immediately.
- Where the power cable may touch a metal case, cover the cable with friction tape. A short circuit or disconnected wire may cause a fire.
- While installing the Rear View System be careful with the wire positioning in order to avoid wire damage.
- The Rear View System should only be used when the vehicle is in reverse.
- Do not watch movies or operate the monitor while driving; as it may cause an accident.
- Do not install the monitor where it may obstruct drivers view or obstruct an air bag device.
- Dropping the unit may cause possible mechanical failure.

*If you have questions about this product, contact:*

***Rear View Safety  
1797 Atlantic Avenue  
Brooklyn, NY 11233  
Tel: 1.800.764.1028***

IN NO EVENT SHALL SELLER OR MANUFACTURER BE LIABLE FOR ANY DIRECT OR CONSEQUENTIAL DAMAGES OF ANY NATURE, OR LOSSES OR EXPENSES RESULTING FROM ANY DEFECTIVE PRODUCT OR THE USE OF ANY PRODUCT.



A Safe Fleet Brand

Before drilling please check that no cable or wiring is on the other side of the wall. Please clamp all wires securely to reduce the possibility of them being damaged while vehicle is in use. Keep all cables away from hot or moving parts and electrical noisy components.

***We recommend doing a benchmark test before installation to insure that all components are working properly.***

Step 1: Choose the monitor and camera locations.

Step 2: Install all cables in vehicle, when necessary a 0.8 (20mm) hole should be drilled for passing camera cable through vehicles walls. Install split grommets where applicable.

Step 3: Once all cables and wiring have been properly routed, perform a system function test by temporarily connecting the system. If the system seems to not be operating properly see troubleshooting (page 21).

### *Replacement Monitor*

The mirror monitor replaces the existing car mirror. Carefully remove the mirror off the “pin”. Slide the replacement mirror on to the pin and secure it with the screw provided (already in the screw hole). Different cars have different brackets. Depending on your vehicle make and manufacturer. There are many methods to remove the original rear-view mirror, however, please don't force the mirror off the bracket. The manufacturer will not be responsible for damage caused to your car by wrong installation of the mirror. Figure 1.1

### *Clip-On Monitor*

1. The Mirror Monitor attaches to the existing rear view mirror in vehicle with the pressurized clips on the back of the monitor.
2. Attach monitor to existing mirror, and adjust mounting angle to allow optimum driver viewing comfort.

### *Camera & Cable*

Be sure to position the cable properly. The aviation camera cable uses aircraft grade connectors which means the camera cable can be exposed to all weather elements. Do not run the cable over sharp edges, do not kink the cable and keep away from HOT and rotating parts. Fasten all cables and secure all excess cable. Connect camera to the camera extension cable which runs inside the vehicle. Figure 1.2



## *Wiring*

After connecting the camera to the “camera cable” the camera should be plugged into AV2 input. Connect the RED 12V power wire to an ignition power source and the BLACK 12V ground wire to a chassis ground. The GREEN wire is the REVERSE trigger wire. Connect this wire to the vehicle’s backup light circuit to activate the rear-view image whenever the vehicle shifts into reverse. To connect a second camera, connect it to AV1 input. It can be turned on by pressing the power button on the monitor. Figure 2.1, Figure 2.2

## *Precautions for use of Mirror Monitor*

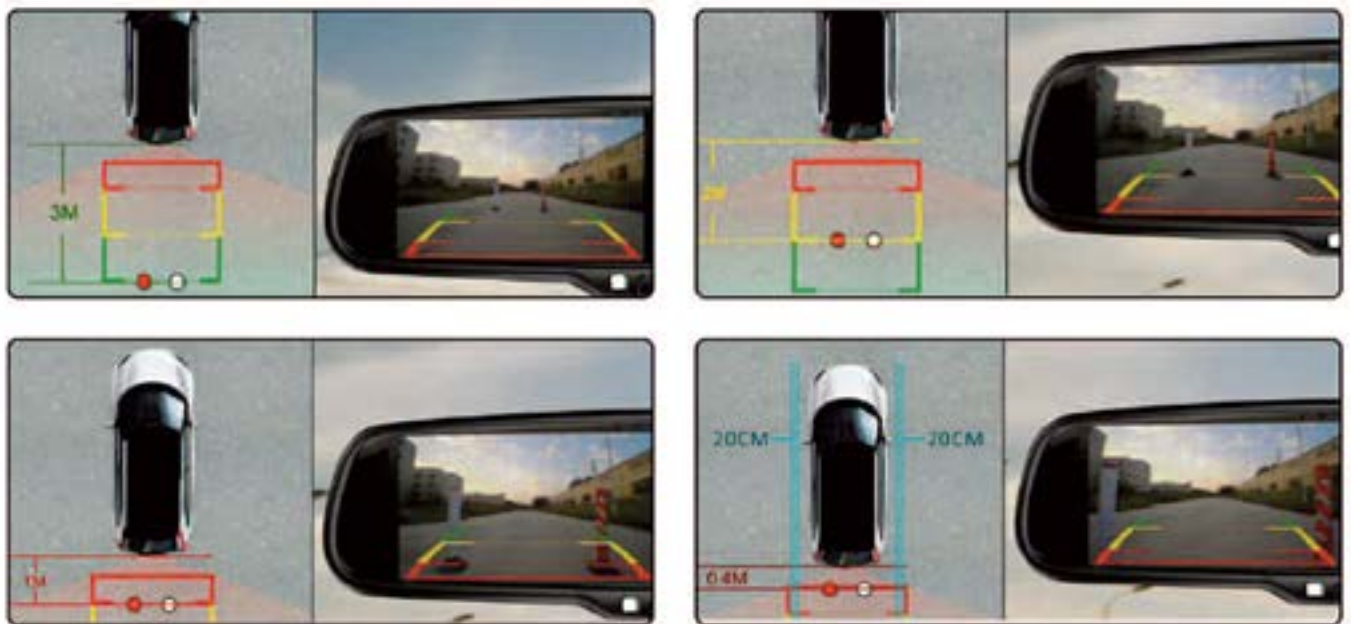
- I.** The Mirror Monitor is made of glass. Do not subject it to a mechanical shock by dropping it from a high place, etc.
- II.** Do not apply excessive force to the monitor surface or the adjoining areas since this may cause the color tone to vary.
- III.** Clean with a soft dry cloth and/or Windex only.
- IV.** Do not attempt to disassemble the mirror monitor.

## *Safety*

- Before drilling, be sure no cable or wire is on the other side.
- Feed as much cable as possible into vehicle & clamp securely. This reduces the possibility of cable being hooked or snagged.

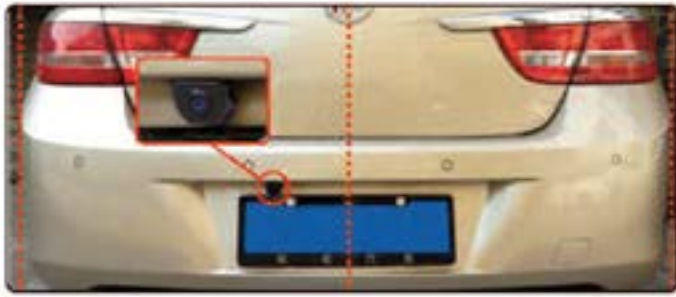
## Grid Lines

Generally, to help drivers estimate the distance from obstacles, there are three lines for reference- red, yellow, and green. Those three lines are displayed on the monitor when car is reversing. The green line is 3M from the back of the car and the yellow line is 6.5 ft. The distant red line is 1M from the backside of car while the close red line is 0.4M. Both reference lines on the left and right should leave 0.2M space from the car.



## Accuracy

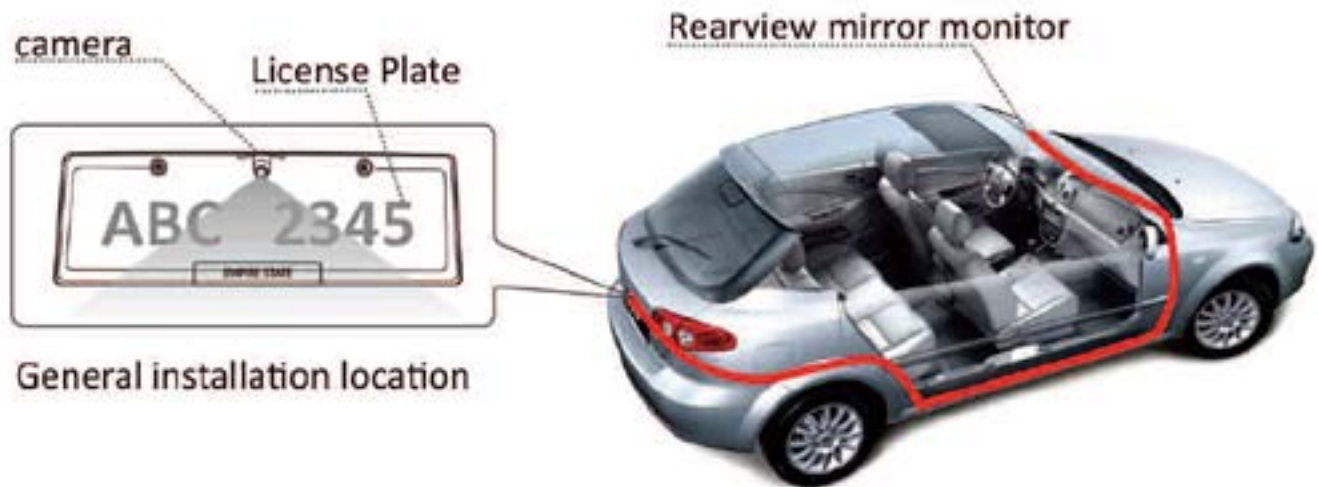
The accuracy of the grid-lines can vary based on how you angle your camera. Therefore to compensate for inaccuracies, you can adjust the grid-lines to your camera angle.



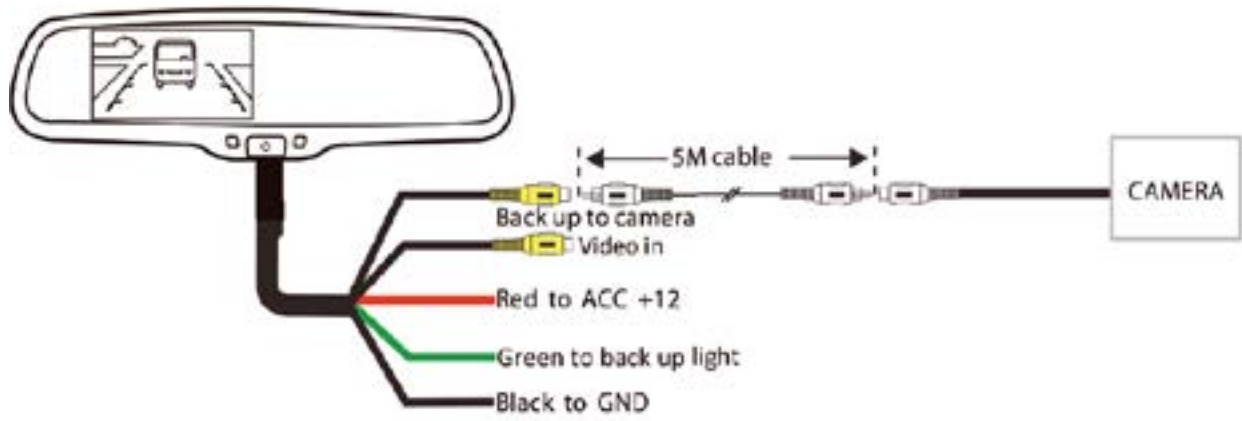
**FIGURE 1.1**



**FIGURE 1.2**

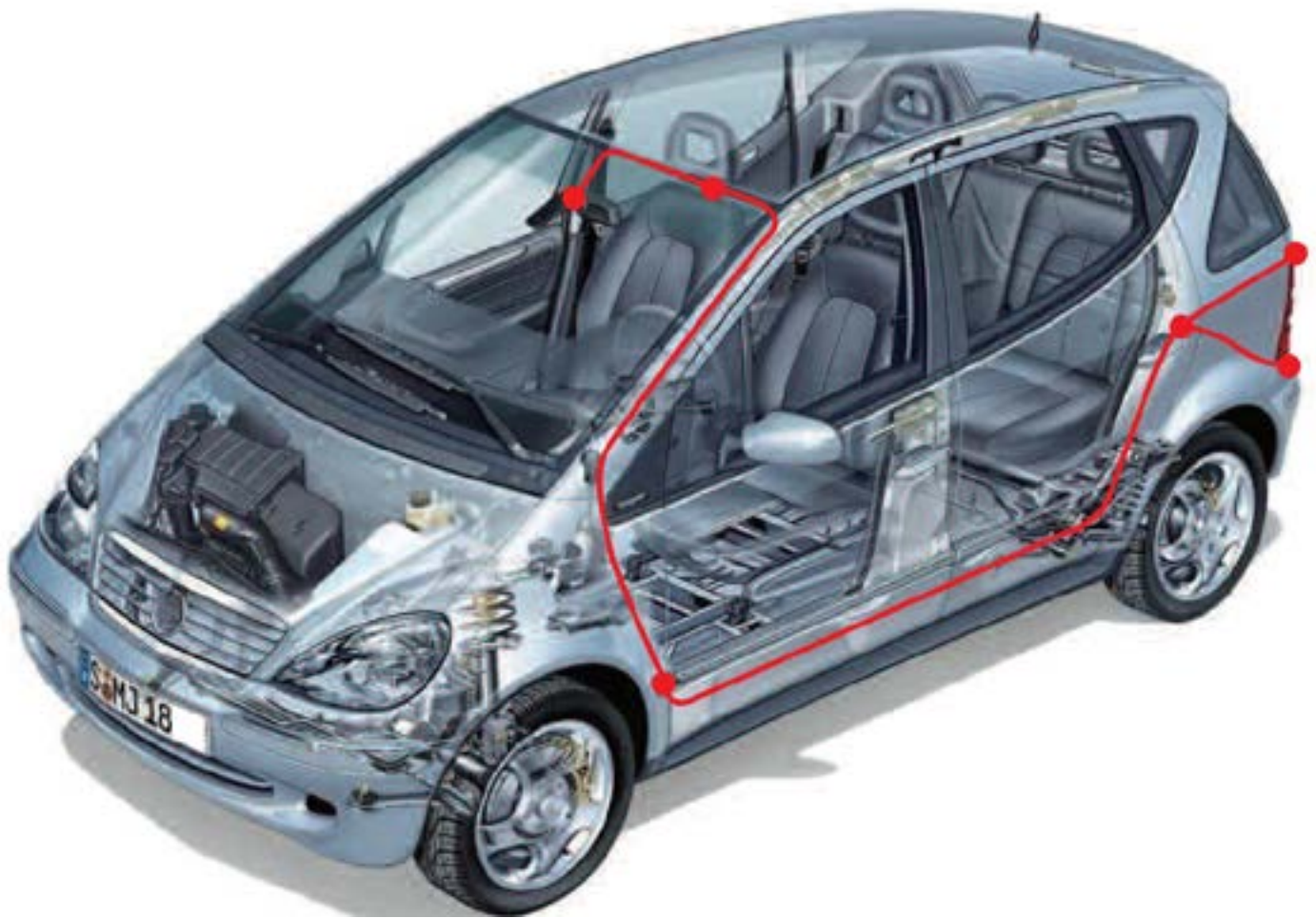


**FIGURE 2.1**



1. RED- Power (+)
2. YELLOW- Video
3. GREEN- Mirror / Normal Imaging
4. WHITE- Audio
5. BLACK- Ground (-)

**FIGURE 2.2**



## Auto Dimming

The auto-dimming feature automatically dims the rear view mirror based on the brightness of vehicles behind your car. This feature eliminates glare and works automatically when the car is on.



front light sensor detects the light from rearward-approaching vehicles.

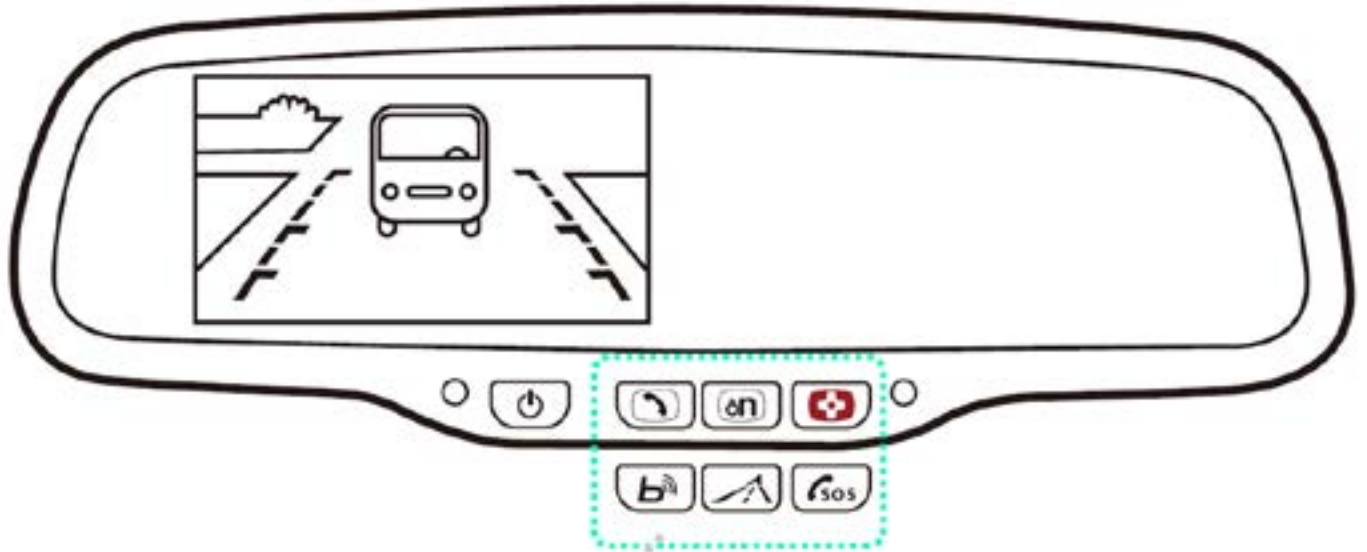
## Auto-dimming bleaching state



## Auto-dimming working state

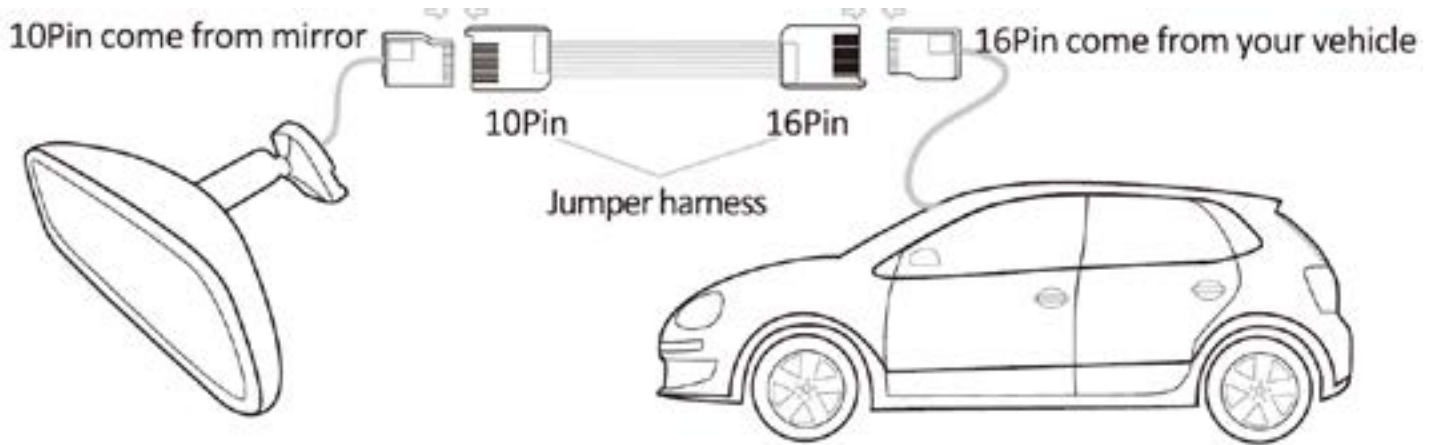


## The buttons



Special for GM OnStar system and HYUNDAI BlueLink system





There are two different OnStar connector cables for rear view mirrors, 10-pin and 16-pin. Our mirror uses a 10-pin connector. A jumper harness can be used to convert a 16-pin connector to a 10-pin connector if necessary.

## About Our Monitor



### SPECIFICATIONS:

Screen Size:	4.3"
Display Screen:	TFT-LCD
Display Resolution:	400(H)x234(V)
Aspect Ratio:	16:9
Color Depth:	16.7M dithering
Pixel Pitch (mm)	0.219x0.219
Power Consumption:	8W
Working Voltage:	DC 9V-32V
Video Input:	VIDEO-IN to GPS/DVD (Default) Camera to backup camera
Signal System:	PAL/Auto/NTSC

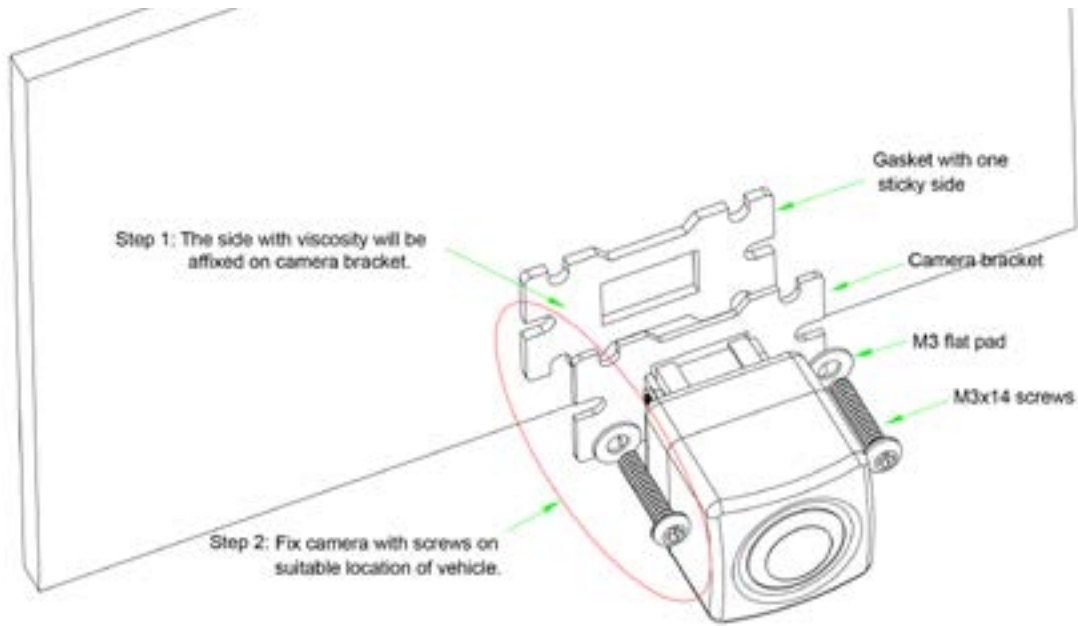
## About Camera



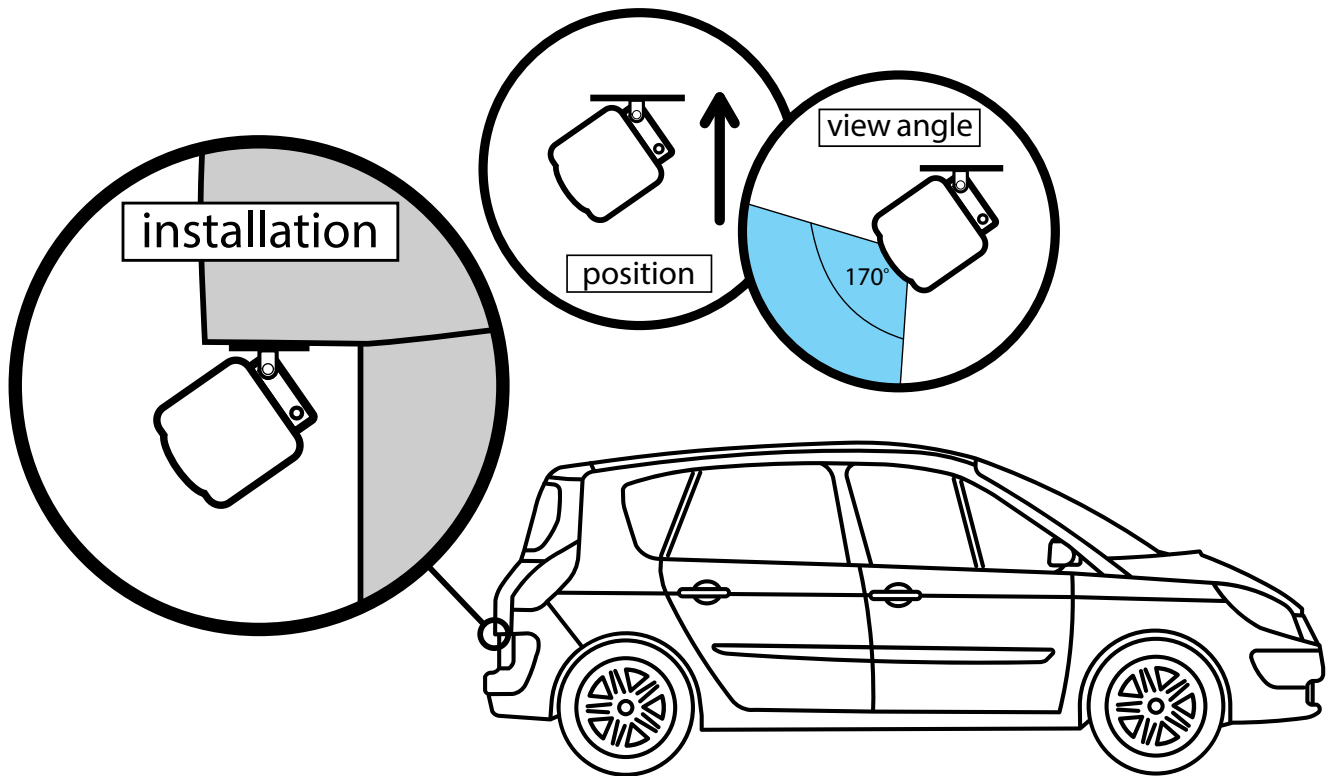
## SPECIFICATIONS:

SENSOR	1/4 INCH MT9V139
SENSOR FORMAT	728 (H) X 560 (V)
TV SYSTEM	PAL 720 X 576 / NTSC 720 X 480
TV LINES	480
VIEWING ANGLE	170°
WEATHERPROOF RATING	IP68
NIGHT VISION	YES
USABLE ILLUMINATION	0.5 LUX
POWER SOURCE	DC 9V-32V
POWER	<1W
S/N RATIO	48DB
VIDEO OUTPUT	1VP - P, 75 Ω
OPERATING TEMPERATURE	-40°C ~ +70°C / RH 95% MAX
STORAGE TEMPERATURE	-40°C ~ +80°C / RH 95% MAX

# Camera Installation



## Mounting Position



## *No Image On Screen*

- Do a hard reset, unplug all cables and power cables, leave out for 1 minute and then re-connect them
- Check to ensure that the connection to the camera is tight
- Verify camera cable is plugged into port labeled Backup Camera
- Verify that the green positive trigger on power harness is put to power 12v+
- Verify camera is on correct camera input
- Verify cable is connected to monitor
- Verify camera is connected to cable
- Connect known working camera and cable to monitor
- Verify Green trigger is receiving power

## **ONE YEAR WARRANTY**

REAR VIEW SAFETY, INC. WARRANTS THIS PRODUCT AGAINST MATERIAL DEFECTS FOR A PERIOD OF ONE YEAR FROM DATE OF PURCHASE. WE RESERVE THE RIGHT TO REPAIR OR REPLACE ANY SUCH DEFECTIVE UNIT AT OUR SOLE DISCRETION. REAR VIEW SAFETY, INC. IS NOT RESPONSIBLE FOR A DEFECT IN THE SYSTEM AS A RESULT OF MISUSE, IMPROPER INSTALLATION, DAMAGE OR MISHANDLING OF THE ELECTRONIC COMPONENTS. REAR VIEW SAFETY, INC. IS NOT RESPONSIBLE FOR CONSEQUENTIAL DAMAGES OF ANY KIND.

THIS WARRANTY IS VOID IF: DEFECTS IN MATERIALS OR WORKMANSHIP OR DAMAGES RESULT FROM REPAIRS OR ALTERATIONS WHICH HAVE BEEN MADE OR ATTEMPTED BY OTHERS OR THE UNAUTHORIZED USE OF NONCONFORMING PARTS; THE DAMAGE IS DUE TO NORMAL WEAR AND TEAR, THIS DAMAGE IS DUE TO ABUSE, IMPROPER MAINTENANCE, NEGLIGENCE OR ACCIDENT; OR THE DAMAGE IS DUE TO USE OF THE REAR VIEW SAFETY, INC. SYSTEM AFTER PARTIAL FAILURE OR USE WITH IMPROPER ACCESSORIES.

## **WARRANTY PERFORMANCE**

DURING THE ABOVE WARRANTY PERIOD, SHOULD YOUR REAR VIEW SAFETY PRODUCT EXHIBIT A DEFECT IN MATERIAL OR WORKMANSHIP, SUCH DEFECT WILL BE REPAIRED WHEN THE COMPLETE REAR VIEW SAFETY, INC. PRODUCT IS RETURNED, POSTAGE PREPAID AND INSURED, TO REAR VIEW SAFETY, INC. OTHER THAN THE POSTAGE AND INSURANCE REQUIREMENT, NO CHARGE WILL BE MADE FOR REPAIRS COVERED BY THIS WARRANTY.

## **WARRANTY DISCLAIMERS**

NO WARRANTY, ORAL OR WRITTEN, EXPRESSED OR IMPLIED, OTHER THE ABOVE WARRANTY IS MADE WITH REGARD TO THIS REAR VIEW SAFETY, INC. REAR VIEW SAFETY, INC. DISCLAIMS ANY IMPLIED WARRANTY OR MERCHANT-ABILITY OR FITNESS FOR A PARTICULAR USE OR PURPOSE AND ALL OTHER WARRANTIES IN NO EVENT SHALL REAR VIEW SAFETY, INC. LIABLE FOR ANY INCIDENTAL, SPECIAL, CONSEQUENTIAL, OR PUNITIVE DAMAGES OR FOR ANY COSTS, ATTORNEY FEES, EXPENSES, LOSSES OR DELAYS ALLEGED TO BE AS A CONSEQUENCE OF ANY DAMAGE TO, FAILURE OF, OR DEFECT IN ANY PRODUCT INCLUDING, BUT NOT LIMITED TO, ANY CLAIMS FOR LOSS OF PROFITS.

## **DISCLAIMER**

REAR VIEW SAFETY AND/OR ITS AFFILIATES DOES NOT GUARANTEE OR PROMISE THAT THE USER OF OUR SYSTEMS WILL NOT BE IN/PART OF AN ACCIDENT OR OTHERWISE NOT COLLIDE WITH AN OBJECT AND/OR PERSON. OUR SYSTEMS ARE NOT A SUBSTITUTE FOR CAREFUL AND CAUTIOUS DRIVING OR FOR THE CONSISTENT ADHERENCE TO ALL APPLICABLE TRAFFIC LAWS AND MOTOR VEHICLE SAFETY REGULATIONS. THE REAR VIEW SAFETY PRODUCTS ARE NOT A SUBSTITUTE FOR REARVIEW MIRRORS OR FOR ANY OTHER MOTOR VEHICLE EQUIPMENT MANDATED BY LAW. OUR CAMERA SYSTEMS HAVE A LIMITED FIELD OF VISION AND DO NOT PROVIDE A COMPREHENSIVE VIEW OF THE REAR OR SIDE AREA OF THE VEHICLE. ALWAYS MAKE SURE TO LOOK AROUND YOUR VEHICLE AND USE YOUR MIRRORS TO CONFIRM REARWARD CLEARANCE AND THAT YOUR VEHICLE CAN MANEUVER SAFELY. REAR VIEW SAFETY AND/OR ITS AFFILIATES SHALL HAVE NO RESPONSIBILITY OR LIABILITY FOR DAMAGE AND/OR INJURY RESULTING FROM ACCIDENTS OCCURRING WITH VEHICLES HAVING SOME OF REAR VIEW SAFETY PRODUCTS INSTALLED AND REAR VIEW SAFETY AND/OR ITS AFFILIATES, THE MANUFACTURER, DISTRIBUTOR AND SELLER SHALL NOT BE LIABLE FOR ANY INJURY, LOSS OR DAMAGE, INCIDENTAL OR CONSEQUENTIAL, ARISING OUT OF THE USE OR INTENDED USE OF THE PRODUCT. IN NO EVENT SHALL REAR VIEW SAFETY AND/OR ITS AFFILIATES HAVE ANY LIABILITY FOR ANY LOSSES (WHETHER DIRECT OR INDIRECT, IN CONTRACT, TORT OR OTHERWISE) INCURRED IN CONNECTION WITH THE SYSTEMS, INCLUDING BUT NOT LIMITED TO DAMAGED PROPERTY, PERSONAL INJURY AND/OR LOSS OF LIFE. NEITHER SHALL REAR VIEW SAFETY AND/OR ITS AFFILIATES HAVE ANY RESPONSIBILITY FOR ANY DECISION, ACTION OR INACTION TAKEN BY ANY PERSON IN RELIANCE ON REAR VIEW SAFETY SYSTEMS, OR FOR ANY DELAYS, INACCURACIES AND/OR ERRORS IN CONNECTION WITH OUR SYSTEMS FUNCTIONS.



A Safe Fleet Brand

If you have any questions  
about this product, contact:

***Rear View Safety, Inc.  
1797 Atlantic Avenue  
Brooklyn, NY 11233  
800.764.1028***

***Better Cameras. Better Service.  
IT'S OUR GUARANTEE.***