



BLACKVUE™
Over the Cloud

DR750S-2CH Manual



ENGLISH

www.blackvue.com

Table of Contents

Introduction	5
Important safety information	6
Overview	9
In the box.....	9
At a glance	10
Front camera.....	10
Removing and inserting the front camera.....	12
Rear camera.....	13
Removing and inserting the rear camera.....	13
Installation	14
Installing the BlackVue dashcam.....	14
Playing and Managing Videos	18
Playing and managing video files using your smartphone (Android/iOS)	18
Opening video files.....	18
BLACKVUE WI-FI screen composition.....	20
Playing video	21
Playing back videos.....	21
Identify video files by recording type	21
Checking the displayed time & GPS data	23
Real-time streaming video (Live View)	24
Managing videos	25
Managing videos in BLACKVUE WI-FI	25
Copy to Internal Memory	25
Managing videos in INTERNAL MEMORY	26
Deleting videos	27
Creating a new folder	27
Copying and pasting videos	27
Moving videos	28
Renaming a video	28
Uploading, sharing or emailing a video	28

Playing and managing video files using your computer (Windows/Mac)	29
Removing the microSD card	29
Opening video files in BlackVue Viewer	30
Viewer screen composition	31
Windows Viewer	31
Mac Viewer	32
Playing video	33
Playing back videos.....	33
Identify video files by recording type	33
Checking the displayed time	35
Using BlackVue Viewer.....	35
Exploring the timeline and G-Sensor graph	36
Zoom options	37
Checking the GPS data.....	38
Managing videos	39
Capturing or printing a still image from video.....	39
Deleting videos	39
For Windows users	39
For Mac users	40
Exporting videos	41
For Windows users	41
Copying videos	42
For Windows users	42
For Mac users	43
Tips for optimal performance	44
Formatting the microSD card	44
Formatting the card in the BlackVue.....	44
Format using BlackVue Viewer (Windows).....	44
Format using BlackVue Viewer (macOS).....	45
Upgrading the firmware	47
Upgrading the firmware using an iOS or Android device (Firmware Over The Air)	47

Upgrading the firmware using a computer (Windows or Mac).....	50
Changing settings	52
Changing settings using your smartphone (Android/iOS)..	52
Basic settings	53
Time settings.....	54
Video settings	56
Resolution	56
Image quality.....	56
Enhanced night vision.....	57
Brightness (Front)	57
Brightness (Rear).....	57
Recording settings.....	58
Recording type settings.....	58
Voice recording.....	58
Date & time display.....	59
Speed unit	59
Video segment length.....	59
Lock event files	59
Rear camera rotation.....	59
Sensitivity settings	60
G-Sensor (Normal mode) / G-Sensor (Parking mode)	61
Motion detection (Parking mode)	62
System settings	63
LED.....	63
Recording status	63
Front security (Normal mode)	63
Front security (Parking mode).....	63
Rear security	64
Wi-Fi (Parking mode).....	64
Proximity Sensor	64
Voice guidance	64
Volume	64
Scheduled Reboot.....	64
Speed alert	65
User text overlay	65
Wi-Fi settings	66
Login credentials.....	66
Wi-Fi auto turn off.....	66

Cloud settings.....	67
Enable Cloud service	67
Cloud service hotspot settings.....	68
Push notification settings.....	69
FW Language	70
Changing settings using your computer (Windows/Mac) ...	71
BlackVue Viewer settings.....	72
Select language.....	72
Speed unit on map.....	72
Select map service	72
Firmware settings	73
Basic settings	74
Time settings.....	74
Video settings.....	75
Recording settings.....	76
Sensitivity settings	78
G-Sensor (Normal mode) / G-Sensor (Parking mode).....	78
Motion detection (Parking mode)	79
Advanced sensitivity settings for normal and parking mode.....	79
System settings	81
LED.....	81
Proximity Sensor	82
Voice guidance	82
Volume	82
Scheduled Reboot.....	82
Speed alert	83
User text overlay	83
Wi-Fi settings	84
Login credentials.....	84
Wi-Fi auto turn off.....	84
Cloud settings.....	85
Enable Cloud service	85
Cloud service hotspot settings.....	86
Push notification settings.....	86
Applying the settings.....	86
About the Cloud Service	87
Connect to BLACKVUE CLOUD (Optional)	87
Optional accessories	92

Parking mode hardwiring kit (Optional)	92
Parking mode battery pack (Optional)	93
Troubleshooting	94
Changing / resetting direct Wi-Fi SSID and password	94
On-device Wi-Fi SSID and password reset.....	94
Change Wi-Fi SSID and password over the Cloud.....	95
Change the Wi-Fi password using BlackVue Viewer (Windows or Mac)	97
Product specifications.....	98
Recording time	100
Disposal and recycling information.....	101

Introduction

Thank you for purchasing this BlackVue dashcam made by Pittasoft Co., Ltd.

This instruction manual contains information on how to operate your dashcam.

Before using your dashcam, we recommend that you read through this manual to ensure correct usage.

To improve the performance of the product, the contents of this manual are subject to change without prior notice.

Note

- A formatted microSD card is provided with the BlackVue dashcam when you purchase the product. Insert the microSD card in the dashcam and power it up. The microSD card will be initialized.

Important safety information

For user safety and to avoid property damage, read through this manual and follow these safety instructions to use the product correctly.



DANGER

Failure to observe the following directions could result in death or property damage:

- **Do not disassemble, repair, or modify the product yourself.**
Doing so may cause fire, electric shock, or malfunction. For internal inspection and repair, contact the service center.
- **If any foreign matter gets inside the product, detach the power cord immediately.**
Contact the service center for repair.
- **Do not adjust the product while driving.**
Doing so may cause an accident. Stop or park your car in a safe place before installing and setting up the product.
- **Do not install the product in a location where the product can interfere with the driver's field of vision.**
Doing so may cause an accident.
- **Do not use a damaged or modified power cord. Only use the cords provided by the manufacturer.**
Damaged or modified power cords may cause an explosion, fire, or malfunction.
- **Do not operate the product with wet hands.**
Doing so may cause electric shock.
- **Do not install the product in an environment with high humidity, or combustible gases or liquids.**
Doing so may cause an explosion and/or fire.



WARNING Failure to observe the following directions could result in death or serious injury:

- **Do not leave the product near infants, children, or pets.**

There is a risk of them swallowing small components, and/or their saliva may get into the product, causing an explosion due to a short circuit.

- **Do not spray water or wax directly onto the product while cleaning the inside of the car.**

Doing so may cause fire, electric shock, or malfunction.

- **If smoke or an unusual smell is emitted from the power cord, detach the power cord immediately.**

Contact the service center or your distributor.

- **Keep the terminals of the power cord clean.**

Failure to do so may cause excessive heat and fire.

- **Use the correct input voltage.**

Failure to do so may cause explosion, fire, or malfunction.

- **Plug in the power cord firmly so that it cannot easily be disconnected.**

Failure to do so may cause fire.

- **Do not cover the product with any material.**

Doing so may cause external deformation of the product or fire. Use the product and peripherals in a well-ventilated location.

**CAUTION**





Failure to observe the following directions could result in injury or property damage:

- **Do not spray cleaning products directly onto the product.**
Doing so may cause discoloration, cracks, or malfunction.
- **If the product is used outside the optimal temperature range (-20°C – 60°C / -4°F – 140°F), performance can decline or malfunctions may occur.**
- **Make sure that the product is installed properly.**
If installed incorrectly, vibrations may cause the product to fall, and may cause physical injury.
- **When entering or exiting a tunnel, when directly facing into bright sunlight, or when recording at night without lighting the quality of recorded video may deteriorate.**
- **If the product is damaged or the power supply is cut due to an accident, video may not be recorded.**
- **Excessively tinted windshield glass can distort the recorded video or cause recorded video to be indistinct.**
- **Prolonged use of the product can increase the interior temperature and cause burns.**
- **microSD cards are consumables, so replace microSD cards after prolonged use.**
microSD cards may not record video correctly after extended use, so check the microSD card's recording capability periodically and replace as necessary.
- **Clean the lens regularly.**
Foreign material attached to the lens can affect the recording quality.
- **Do not remove the microSD card while the microSD card is saving or reading data.**
The data can be damaged or malfunctions may occur.
- **It is recommended that you install the software and firmware from the BlackVue downloads page (www.blackvue.com).**
- **It is recommended that you remove the power cord if the product (BlackVue dashcam/Parking Mode Hardwiring Kit) is not used for an extended period of time.**

Overview

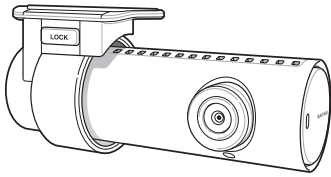
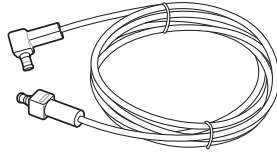
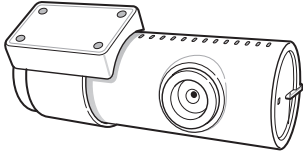
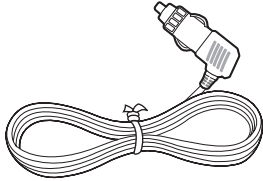
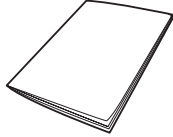
In the box

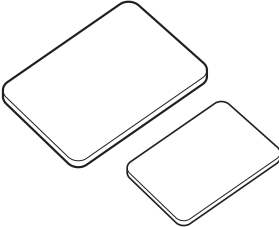
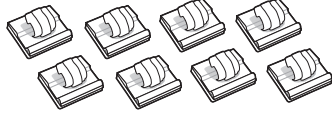
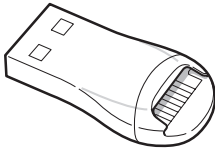
Check the box for each of the following items before installing the BlackVue dashcam.

	Front camera		Rear camera connection cable		Rear camera
	Power cord		Quick start guide		Pry tool
	Double-sided tape for the Mounting Brackets		Cable clips (8 EA)		
	microSD card reader		microSD Card		

Note

- The illustrations in this manual may differ from the product.
- To improve the performance of the product, the contents of this manual are subject to change without prior notice.
- For more information about the package components and accessories, visit the BlackVue website (www.blackvue.com).

➤ At a glance

The following diagrams explain each part of the BlackVue dashcam.

□ Front camera

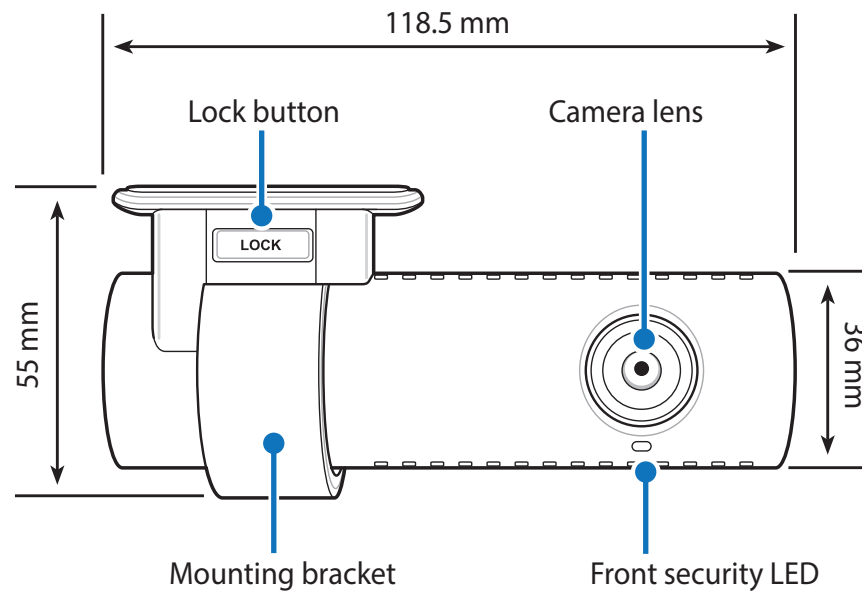

- : Blinks slowly during normal mode and parking mode motion detection standby.
- ◻ : Blinks quickly when (i) an event is being recorded (impact detected), (ii) manual recording has started, or (iii) motion is detected in parking mode.

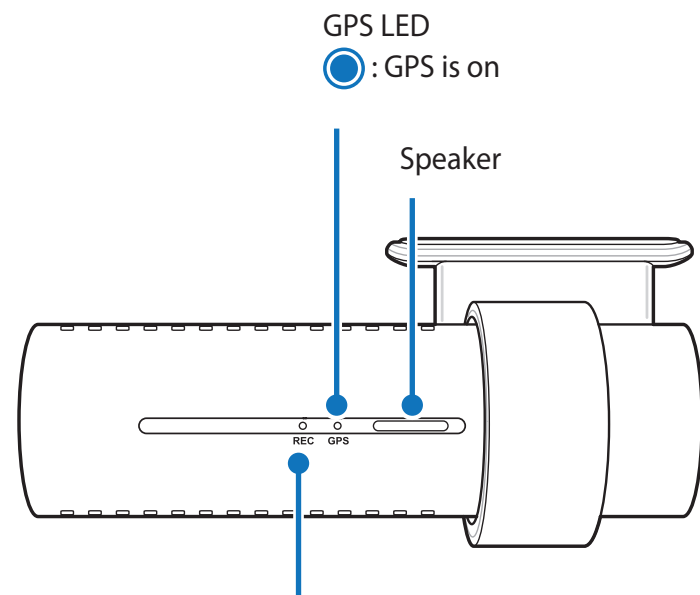

- : GPS is on
- : Blinks orange in normal mode.
- : Blinks red when (i) an event is being recorded (impact detected), or (ii) manual recording has started.
- : Blinks green in parking mode when motion is detected.

Wi-Fi/Internet LED

📶 : Direct Wi-Fi is on.

📶 : Blinks when connected to the internet (Cloud connected).

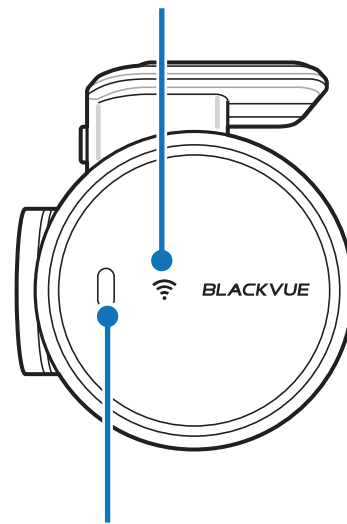

Proximity Sensor:

Touch or wave a finger within 20mm of the sensor to turn on/off audio recording.

Alternatively, it can be set as a manual recording trigger in the firmware settings.

Rear camera connection port

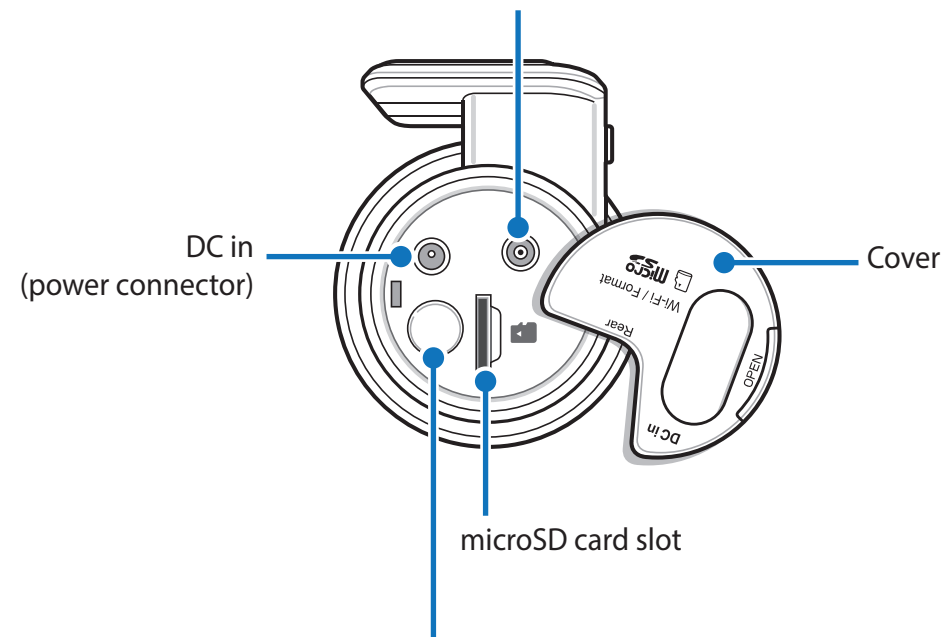

Wi-Fi / Format button:

- Press once to turn on/off Wi-Fi.
- Press and hold for 5 seconds and once voice instructions start, release the button. Then press once again to reset the Wi-Fi SSID and password or press and hold for 5 seconds to format the microSD card.

□ Removing and inserting the front camera

Connectivity details label:

- Default Wi-Fi SSID
- Default Wi-Fi password
- Cloud code
- QR code

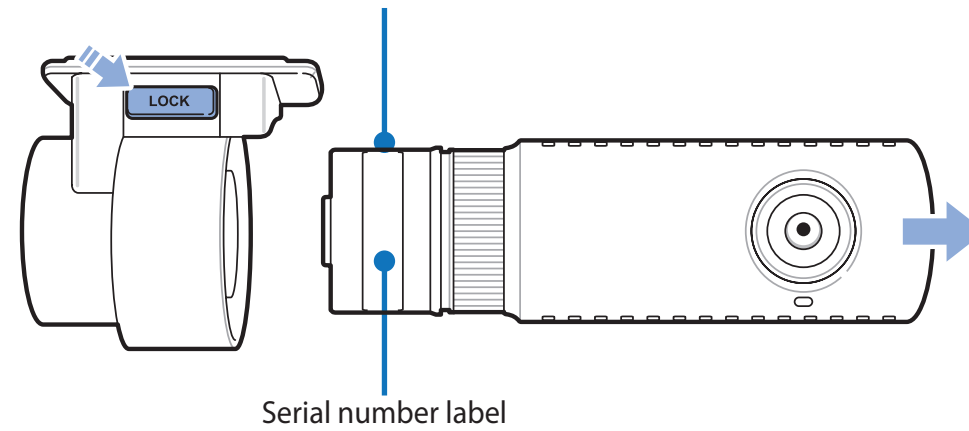

- To remove the dashcam from its bracket, press the LOCK button and pull the dashcam out of the mounting bracket.
- To insert the dashcam into its bracket, push the dashcam into the mounting bracket until it "clicks" in.

□ Rear camera

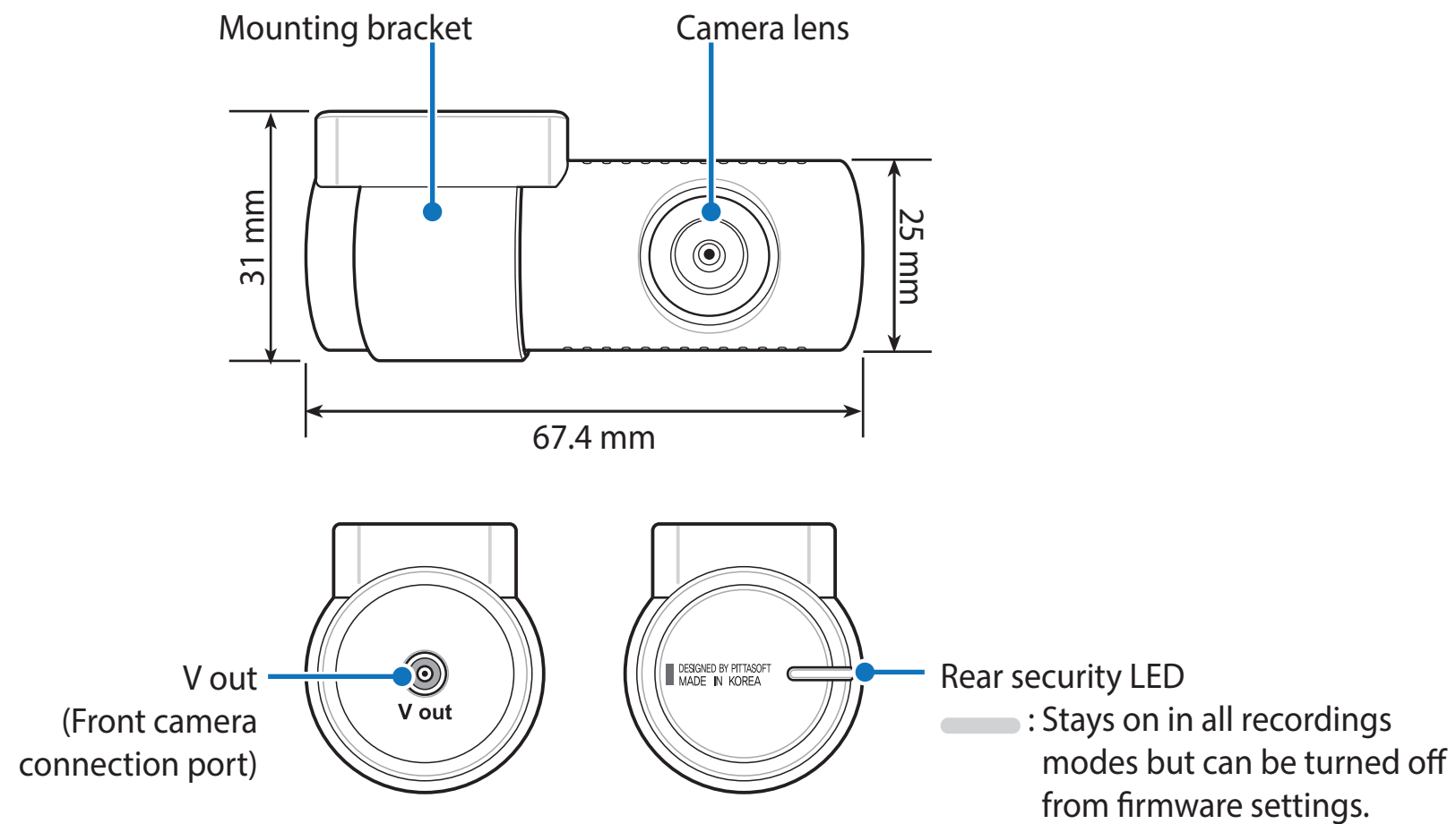

□ Removing and inserting the rear camera

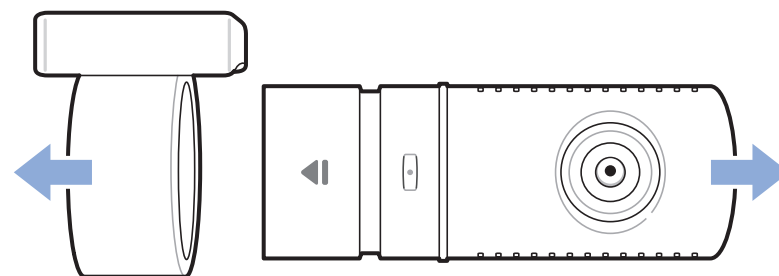

- To remove the rear camera from its bracket, hold the mounting bracket and pull the rear camera out.
- To insert the rear camera into its bracket, push the rear camera into the mounting bracket until it "clicks" in.

Installation

▶ Installing the BlackVue dashcam

Install the front camera behind the rear view mirror. Install the rear camera at the top of the back windshield. Remove any foreign matter and clean and dry the windshield before installation.

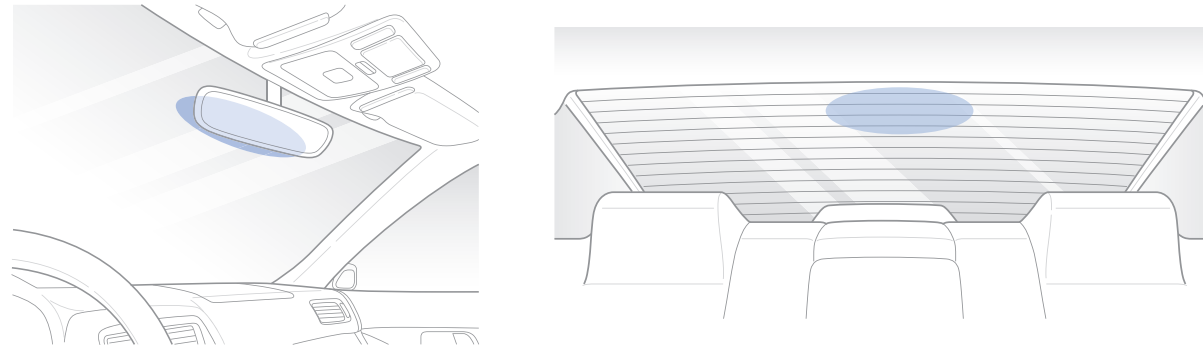

⚠ Warning

- Do not install the product in a location where it can obstruct the driver's field of vision.

- 1 Turn off the engine. Open the cover of the microSD card slot, gently push the card into the slot until it locks into place and close the cover.

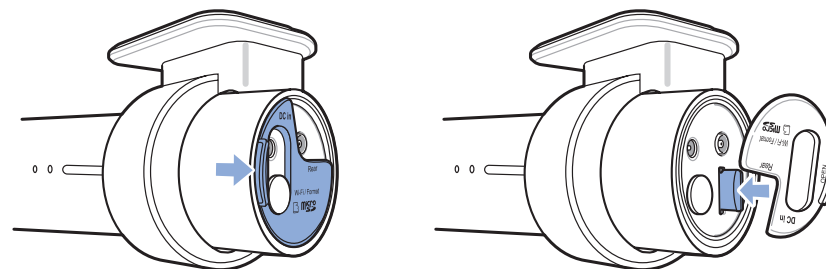

- 2** Peel off the protective film from the double-sided tape and attach the front camera to the windshield behind the rear-view mirror.

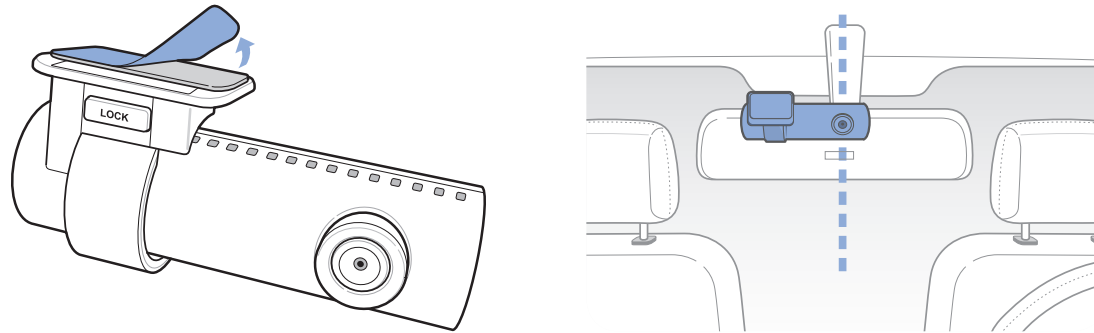

- 3** Adjust the angle of the lens by rotating the body of the front camera. We recommend pointing the lens slightly downwards ($\approx 10^\circ$ below horizontal), so as to record video with a 6:4 road to background ratio.

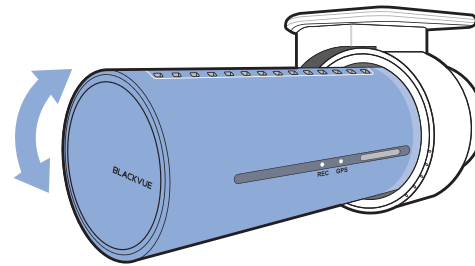

- 4** Peel off the protective film from the double-sided tape and attach the rear camera to the rear windshield. Adjust the angle of the lens by rotating the body of the rear camera.

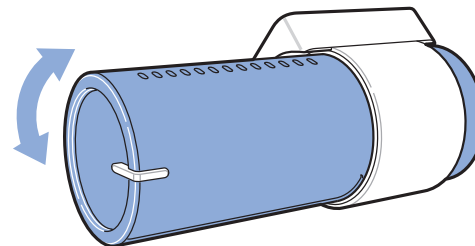

- 5 Connect the front camera ('Rear' port) and the rear camera ('V out') using the rear camera connection cable.

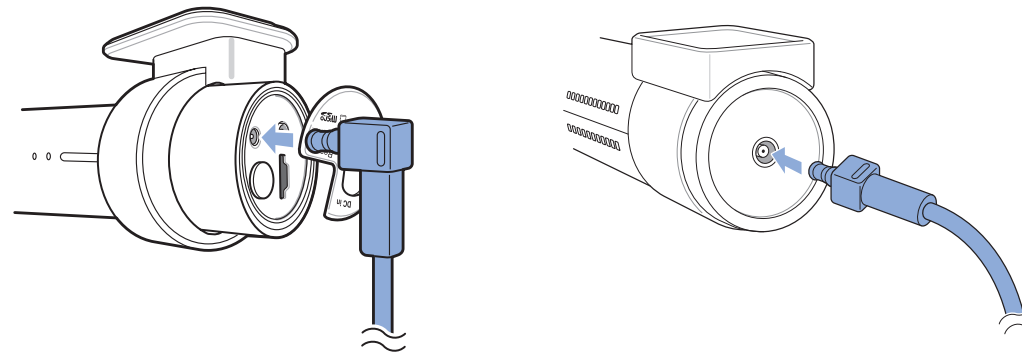

- 6 Use the pry tool to lift the edges of the rubber window sealing and molding and tuck in the rear camera connection cable.

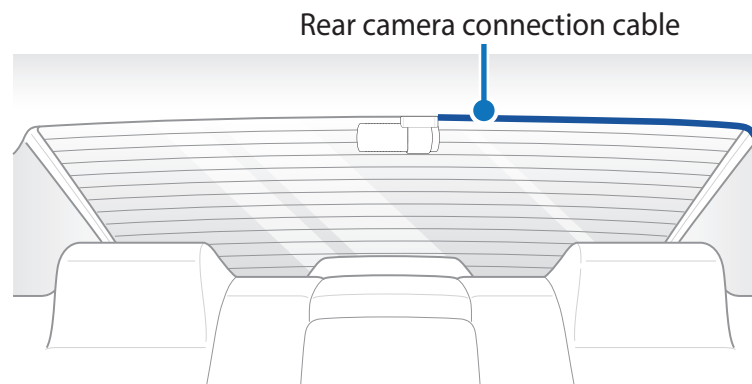

- 7 Plug the power cord into the cigarette lighter socket and the front camera.

- 8 Use the pry tool to lift the edges of the windshield trim/molding and tuck in the power cord.

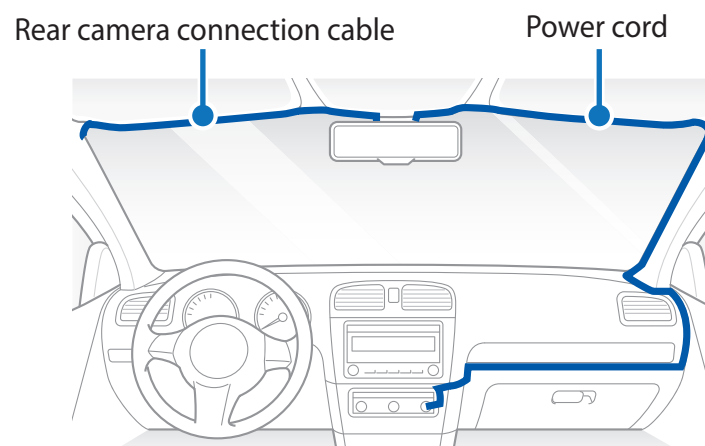

- 9 Turn on the engine. The BlackVue dashcam will power up and start recording. Video files are stored on the microSD card. When the microSD card fills up, the newest video files will start to replace the oldest video files (called loop recording) – so you will always have the most recent video files.
- 10 Turn off the engine. The dashcam will automatically stop recording and power down. To record in parking mode while the engine is off please install a **Power Magic Battery** Pack (sold separately) or a **Power Magic Pro** (sold separately). A **Power Magic Pro** powers your dashcam when the engine is off by hardwiring it to the automotive battery. A low voltage power cut-off function and a parking mode timer protect the automotive battery from discharge.

Note

- Up to 50 event recordings (impact, manual) can be locked from being overwritten. By default, this feature is disabled. You can enable it from firmware settings and choose to either overwrite them with new event files when the event file storage is full or lock the 50 event files and save the new event files in loop recording storage. Please note that formatting the microSD card deletes all the recordings including the locked event files.
- The recording LED blinks while recording (default setting) and the GPS LED is on when a GPS signal is received. There are 4 recording modes: Normal, Event, Parking and Manual. The dashcam starts recording in normal mode, switches to event mode when an impact is detected, and switches to parking mode if the vehicle is stationary for 5 minutes. Touching the proximity sensor turns on/off audio recording or triggers manual recording depending on the firmware settings.
- When you run the dashcam for the first time the firmware is automatically loaded onto the microSD card. After the firmware has been loaded onto the microSD card you can customize settings using BlackVue Viewer on a computer.

Playing and Managing Videos

▶ Playing and managing video files using your smartphone (Android/iOS)

▶ Opening video files

- 1 Search for the BlackVue app in the Google Play Store or Apple App Store and install it on your smartphone.
- 2 “Pair” your smartphone with the BlackVue dashcam via direct Wi-Fi:
 - a. Go to your smartphone's **Settings** then select **Wi-Fi**, and make sure Wi-Fi is turned on.

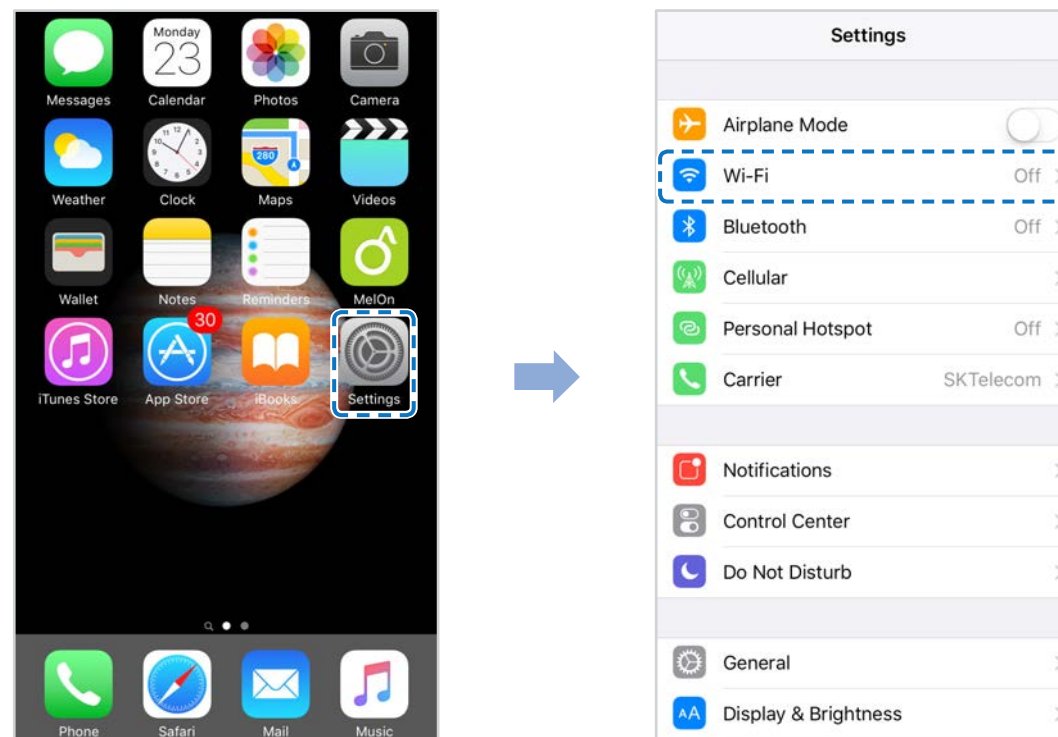

b. Choose your BlackVue dashcam from the network list. The dashcam's default SSID begins with its model number (e.g. BlackVue750S-*****).

c. Enter the password and tap join.

* The default Wi-Fi SSID and password is labeled on the dashcam. To find them, unplug the cables and remove the front camera from its mount.

d. Open the BlackVue app and select BLACKVUE WI-FI.

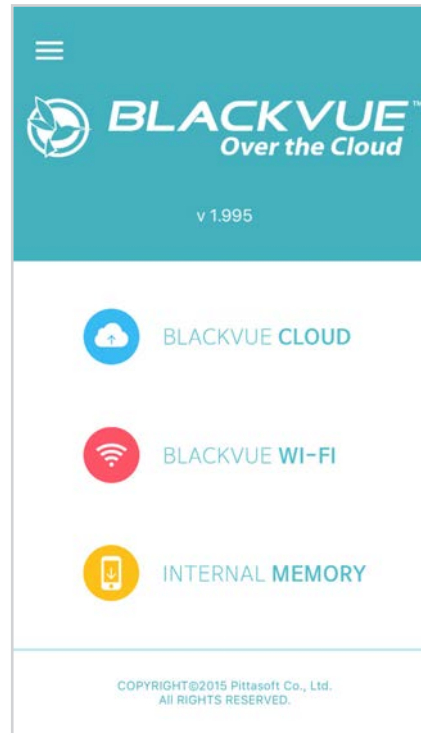

 **Note**

- Direct Wi-Fi lets you directly connect your smartphone to your dashcam via Wi-Fi within a range of 10m.
- The BlackVue app is available for devices running Android 4.2 and higher, or iOS 8.0 and higher.
- You can change Wi-Fi SSID and password as described on page **95** and **97**.

▶ BLACKVUE WI-FI screen composition

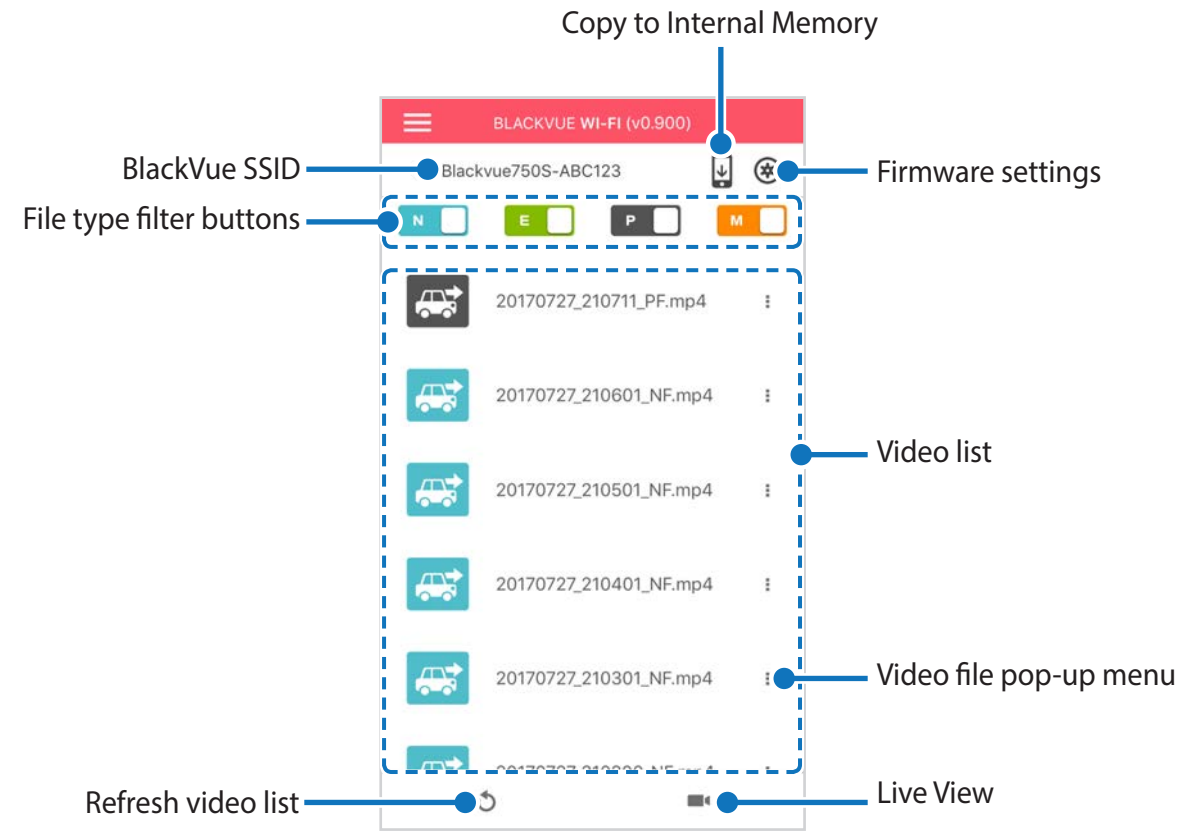



▶ Playing video

□ Playing back videos

Select the video file you want to play from the video list.

Press the refresh button  to refresh the video list.

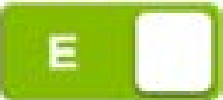
□ Identify video files by recording type

	Normal	The dashcam records in normal mode by default.
	Event	When the dashcam detects an impact while in normal or parking mode, it switches to event mode and saves an event recording beginning 5 seconds before the event trigger. Exceeding the set speed limit will also trigger an event recording.
	Parking	In parking mode the dashcam continuously buffers video. When motion is detected in the dashcam's field of view, it saves a parking recording beginning 5 seconds before the motion detection.
	Manual	If proximity sensor is set as a manual recording trigger in the firmware settings, touching or waving a finger within 20 mm of the sensor will turn on manual recording.

Tap the car icon to load the thumbnail of a recording.

The car icon with an arrow pointing to the right indicates a front dashcam recording.



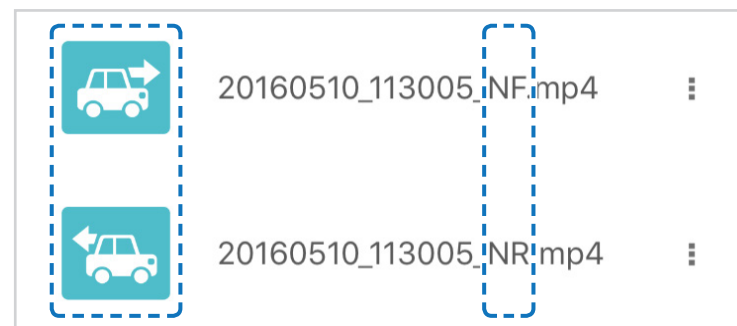

The car icon with an arrow pointing to the left indicates a rear dashcam recording.



Recording file names include the date, time, recording type and camera direction.

- **Recording type:** N: Normal
E: Event
P: Parking mode motion detection
M: Manual
- **Camera direction:** F: Front camera
R: Rear camera
- **Example file name:** 20170104_150838_NF.mp4
Date & time: 4th January 2017, 03:08:38 PM
Recording type: Normal
Camera direction: Front camera

Note

- Use the , , ,  buttons to filter the video list by recording type (Normal, Event, Parking and Manual). The  filter button displays both E (Event) and I (Impact event while parked) recordings.
- The dashcam requires a constant power source to record in parking mode. See "**Optional accessories**" on **page 92** for more information.

☐ Checking the displayed time & GPS data

The time the video was recorded is displayed in the lower left corner of the video in the playback screen. If the displayed time in the recorded videos is incorrect please see **"Time settings" on page 54 or 74.**

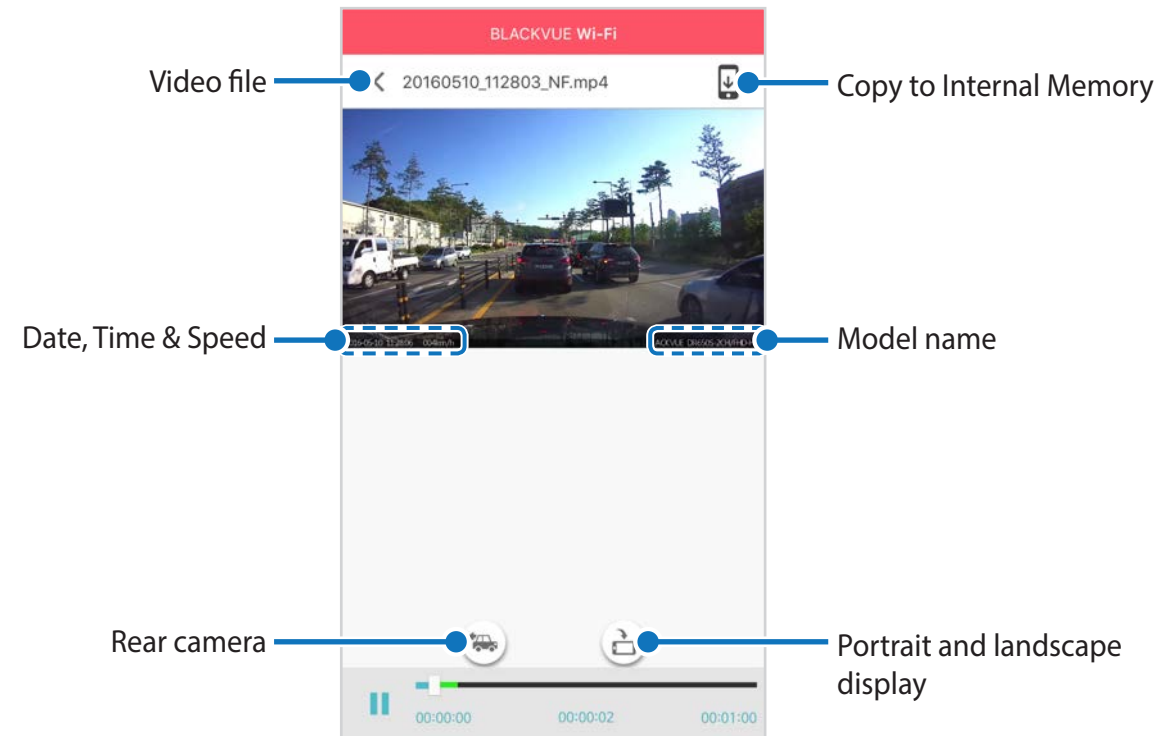

The vehicle's speed is displayed in the lower-left corner of the video.



Rotate your smartphone or press the rotate button  to switch between portrait and landscape display modes.

Press the rear button  to switch to the rear dashcam view.

➤ Real-time streaming video (Live View)

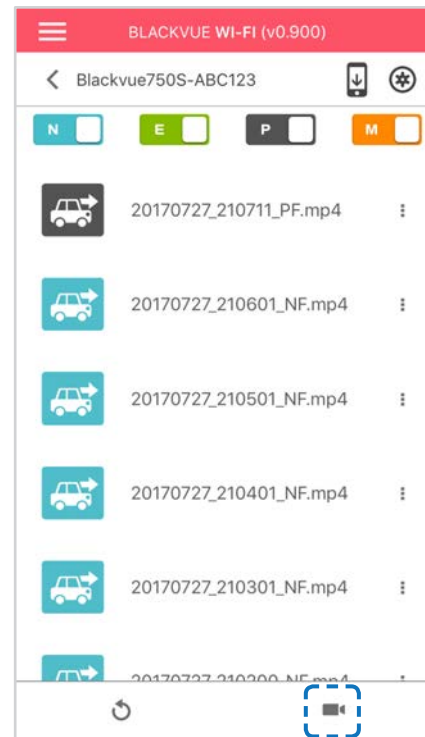
You can view in real-time the video currently being recorded by connecting your smartphone to the dashcam via direct Wi-Fi.



- 1 Go to your smartphone's **Settings** > **Wi-Fi** and connect to your dashcam.
- 2 Open the BlackVue app. Select **BLACKVUE WI-FI** and tap the  button.
- 3 Rotate your smartphone or press the rotate button  to switch between portrait and landscape display modes.
- 4 Press the rear button  to switch to the rear dashcam view.

Note

- When watching Live View via direct Wi-Fi, map data isn't displayed because your smartphone can't access internet as long as it is connected to dashcam's Wi-Fi.

➤ Managing videos

☐ Managing videos in BLACKVUE WI-FI

You can manage the recorded videos using the BlackVue app.

📝 Note

- When the microSD card fills up, the newest video files will start to replace the oldest video files (called loop recording) – so you will always have the most recent video files.

■ Copy to Internal Memory

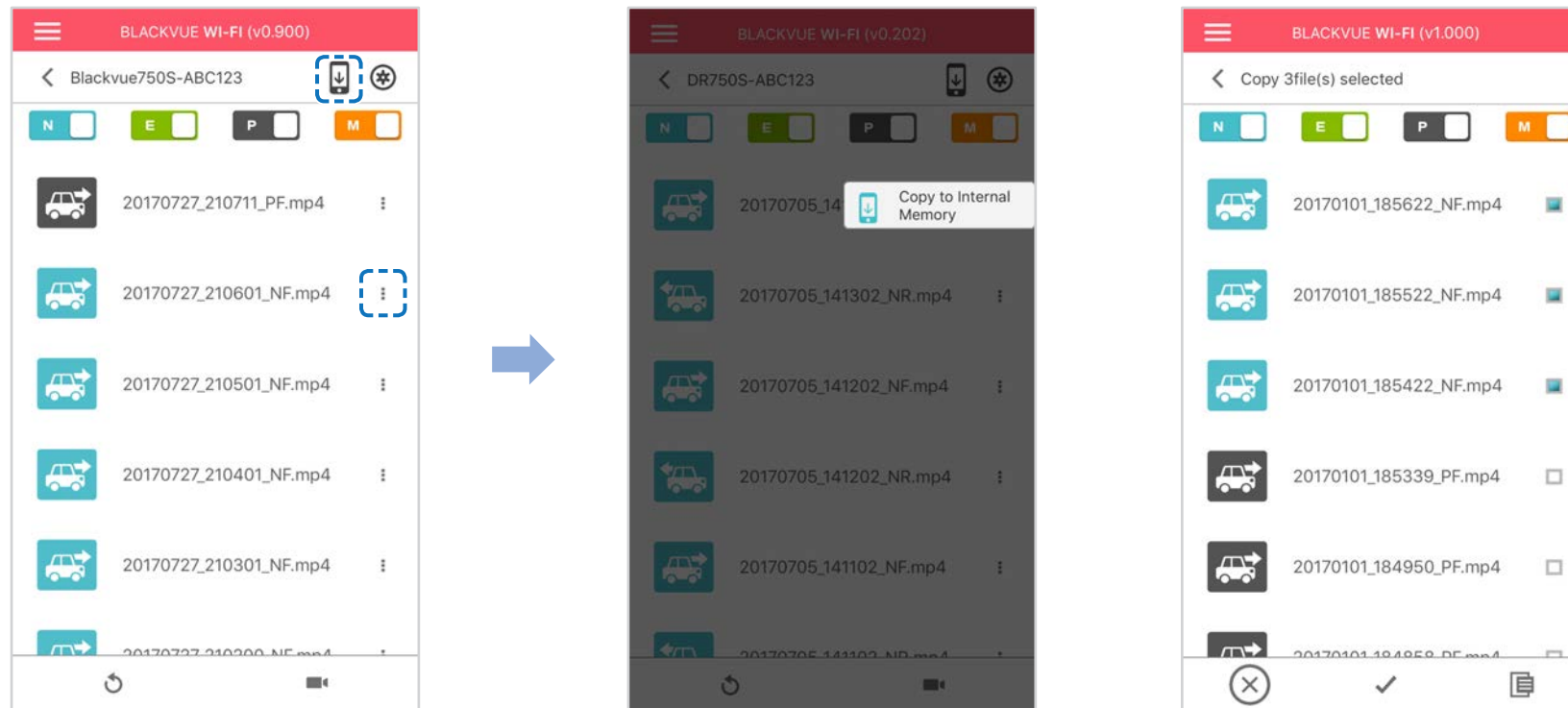



To copy individual files to your smartphone, tap  next to the video you want to copy. Select Copy to Internal Memory.

To copy multiple files to your smartphone in one go tap . Select which files to copy, or tap  to select all files. Tap  to begin copying.

Managing videos in INTERNAL MEMORY

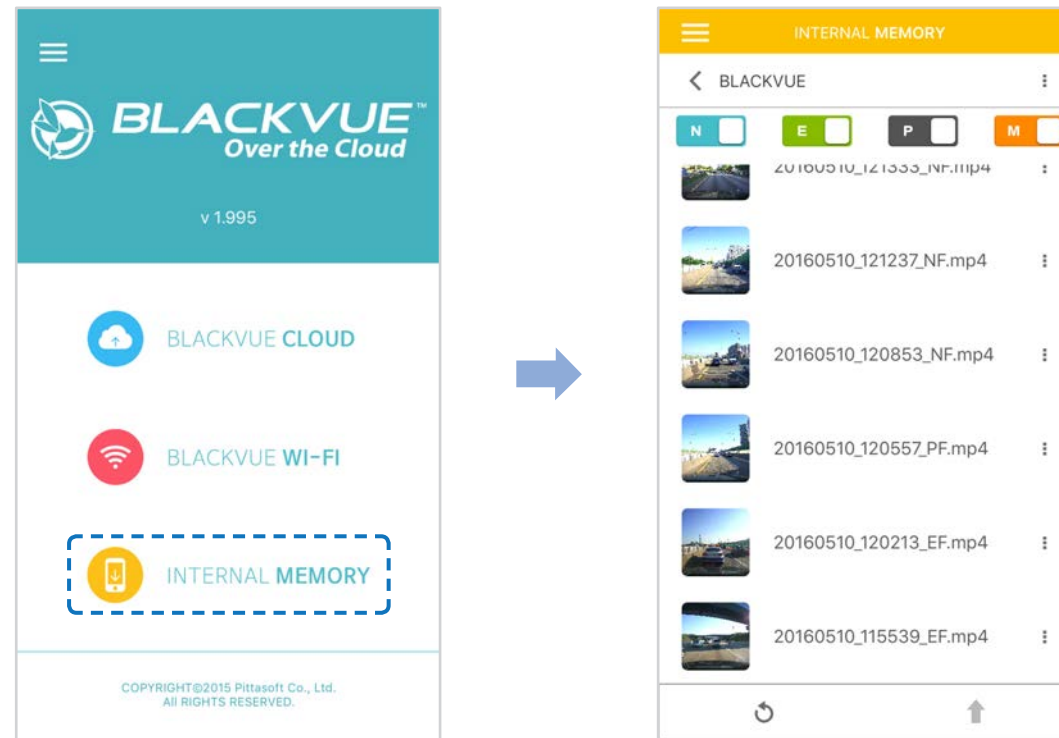
Open the BlackVue app and select INTERNAL MEMORY.



Tap  to see file options. You can delete, copy or move files, change the name of files and share files.

■ Deleting videos

To delete multiple files from your smartphone in one go, tap at the top of the screen and select **Delete**. Select which files to delete, or tap ✓ to select all files. Tap 🗑️ to delete the selected files.

To delete individual files, tap ⋮ next to the video you want to delete. Select **Delete**.

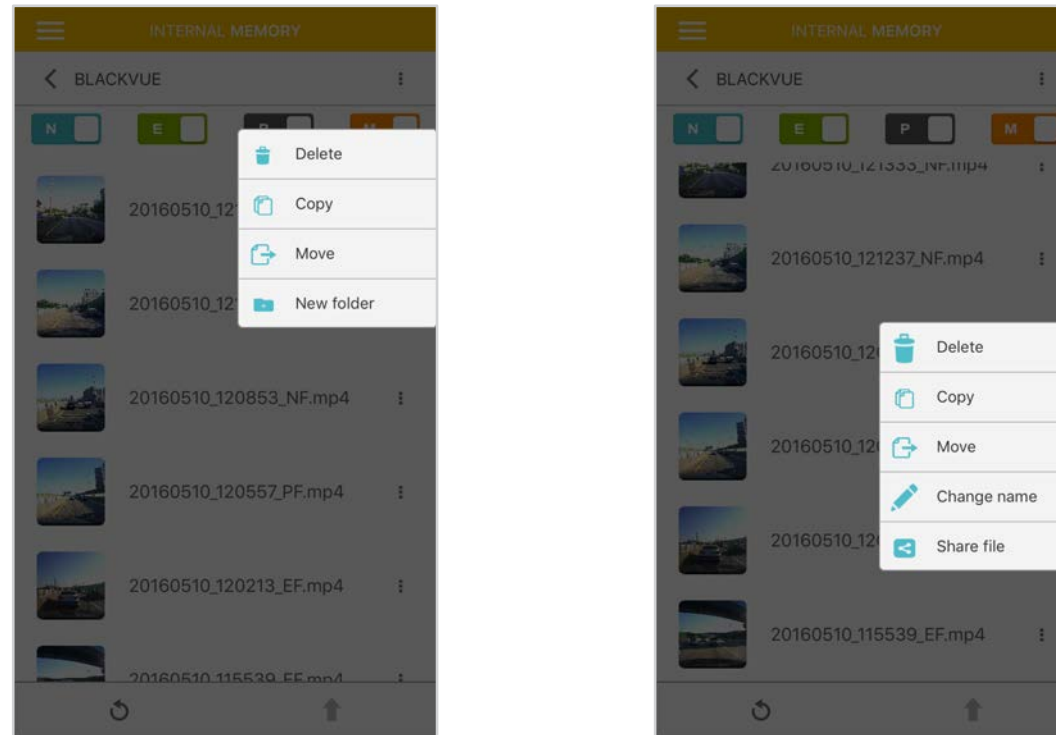

■ Creating a new folder





To create a new folder tap at the top of the screen and select **New folder**. Enter a new folder name and press OK.

■ Copying and pasting videos

To copy multiple files in one go, tap at the top of the screen and select **Copy**. Select which files to copy, or tap ✓ to select all files. Tap 📄 to copy the selected files. Go to another folder and tap 📄 to paste the selected files there.

To copy individual files, tap ⋮ next to the video you want to copy. Select **Copy**. Go to another folder and tap 📄 to paste the file there.

■ Moving videos

To move multiple files in one go, tap  at the top of the screen and select **Move**. Select which files to move, or tap  to select all files. Tap  and go to another folder and tap  to move the selected files there.

To move individual files, tap next to the video you want to move. Select **Move**. Go to another folder and tap to move the file there.

■ Renaming a video

To rename a video, tap  next to the video you want to rename. Select **Change name**. Enter a new name and tap **OK**.

■ Uploading, sharing or emailing a video

Tap  next to the video you want to share. Select **Share file**. Choose the app you want to share with. The available options will depend on what apps you have installed on your smartphone.

▶ Playing and managing video files using your computer (Windows/Mac)

➤ Removing the microSD card

- 1 Unplug the power cord to turn off the dashcam.
- 2 Open the cover of the microSD card slot.
- 3 To remove the microSD card, gently press on the card to release the lock then carefully pull the card out.
To insert the microSD card, gently push the card into the slot until it locks into place and close the cover.

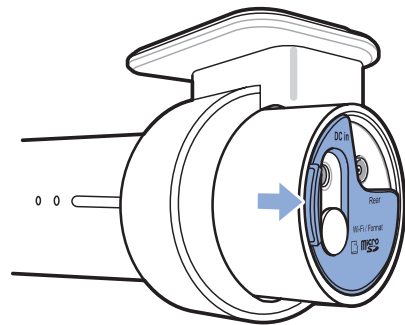

Open side cover

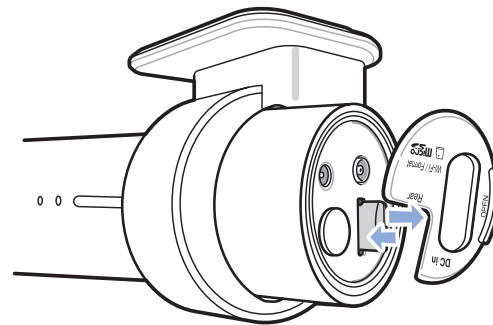

To remove

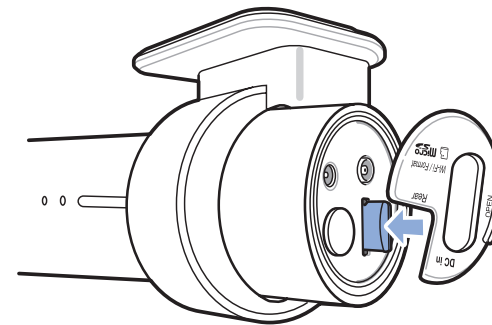

To insert

➤ Opening video files in BlackVue Viewer

- 1 Remove the microSD card from the dashcam.
- 2 Insert the card into the microSD card reader and connect it to a computer.

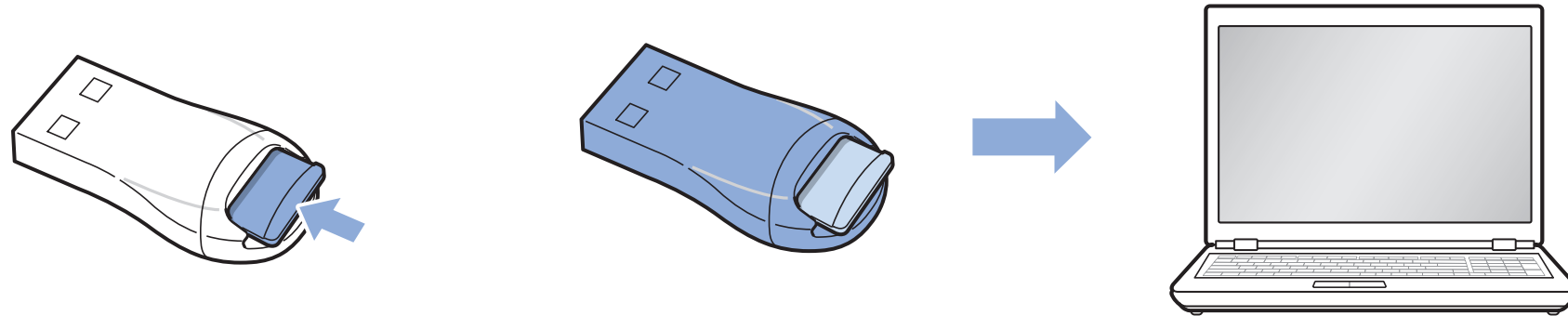

- 3 Download BlackVue Viewer from www.blackvue.com > **Support** > **Downloads** and install it on your computer.
- 4 Run BlackVue Viewer. To play, select a video and click on the play button or double click the selected video.

Viewer screen composition

Windows Viewer

When you launch the program, you will see the SD card Viewer window. To open Cloud Viewer, click the  button.

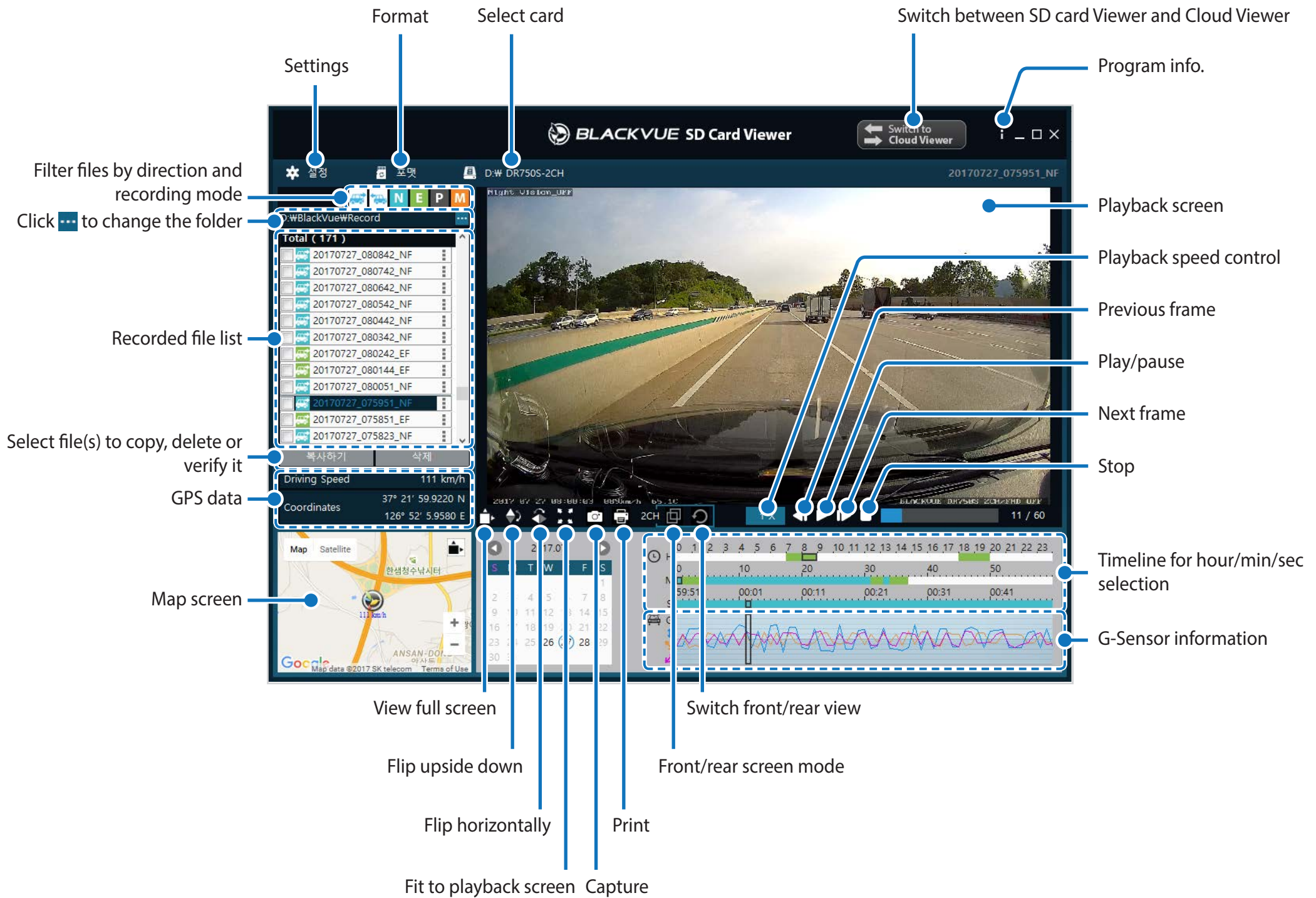

Mac Viewer

When you launch the program, you will see the SD card Viewer window. To open Cloud Viewer, click the  button.

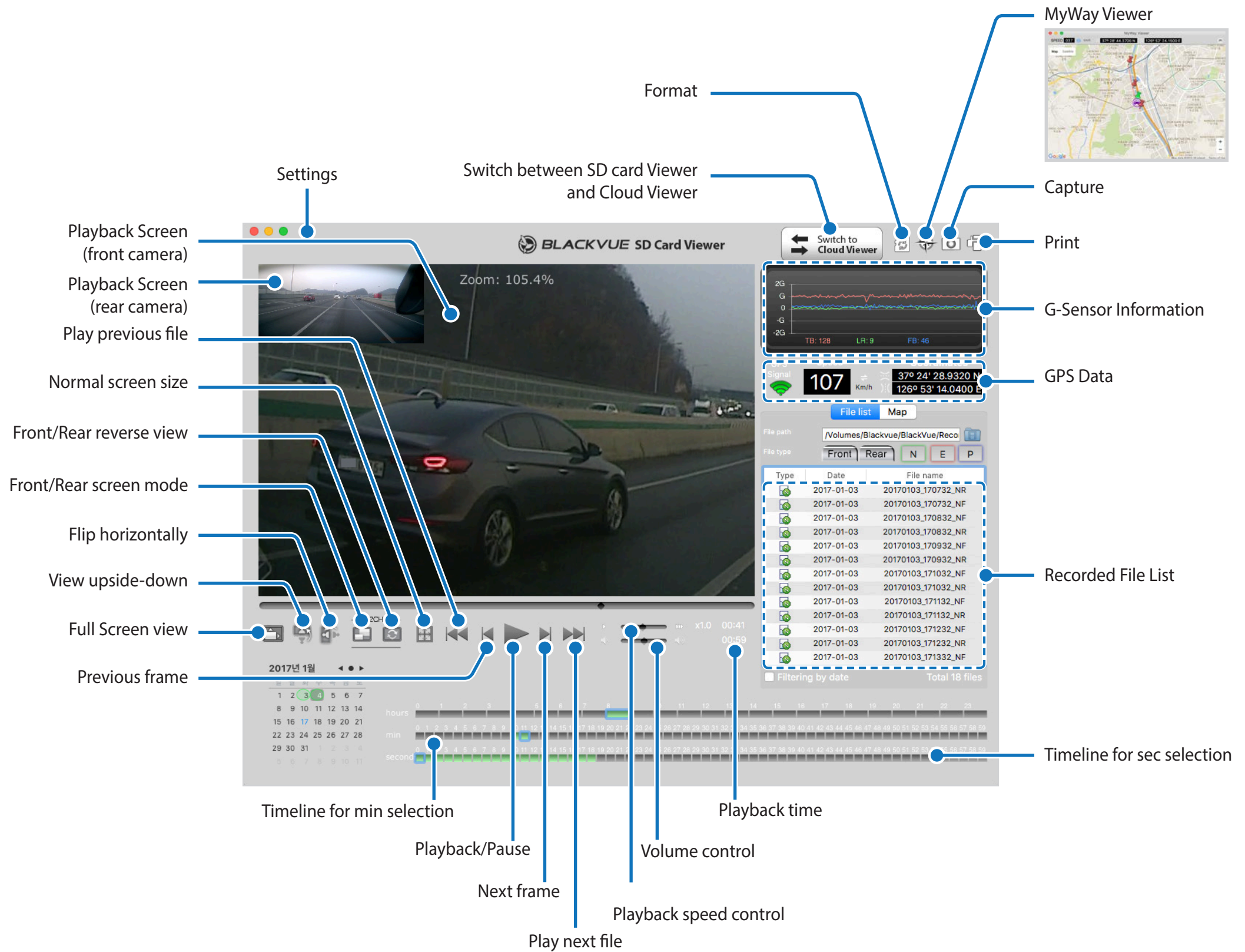













Playing video

Playing back videos

In BlackVue Viewer double click a video file to play.

BlackVue Viewer shows by default the files in the microSD card. To see files in another folder click the  button and browse to the folder.



Identify video files by recording type





<input type="checkbox"/>		20161215_171828_PR	
<input type="checkbox"/>		20161215_171732_PF	
<input type="checkbox"/>		20161215_171732_PF	
<input type="checkbox"/>		20161031_213100_NF	
<input type="checkbox"/>		20160825_081954_NF	
<input type="checkbox"/>		20160825_081853_NF	

Parking mode, Front camera

Parking mode, Rear camera

- **Recording type:**
 - N: Normal
 - E: Event
 - P: Parking mode motion detection
 - M: Manual
- **Camera direction:**
 - F: Front camera
 - R: Rear camera
- **Example file name:** 20170104_150838_NF.mp4
 - Date & time: 4th January 2017, 03:08:38 PM
 - Recording type: Normal
 - Camera direction: Front camera

Use the  buttons to filter the video list by recording type. The  filter button displays both E (Event) and I (Impact event while parked) recordings.

	Normal	The dashcam records in normal mode by default.
	Event	When the dashcam detects an impact while in normal or parking mode, it switches to event mode and saves an event recording beginning 5 seconds before the event trigger. Exceeding the set speed limit will also trigger an event recording.
	Parking	In parking mode the dashcam continuously buffers video. When motion is detected in the dashcam's field of view, it saves a parking recording beginning 5 seconds before the motion detection.
	Manual	If proximity sensor is set as a manual recording trigger in the firmware settings, touching or waving a finger within 20mm of the sensor will turn on manual recording.

The car icon with an arrow pointing to the right indicates a front dashcam recording.

The car icon with an arrow pointing to the left indicates a rear dashcam recording.

Note

- The dashcam requires a constant power source to record in parking mode. See "**Optional accessories**" on page 92 for more information.
- Depending on the specifications of your computer, the dashcam videos that are recorded at 60fps, may not play smoothly or at higher speeds (2x, 4x, etc.).

☐ Checking the displayed time

The time the video was recorded is displayed in the lower left corner of the video in the playback screen. If the displayed time in the recorded videos is incorrect please see **"Time settings" on page 54 or 74.**

☐ Using BlackVue Viewer

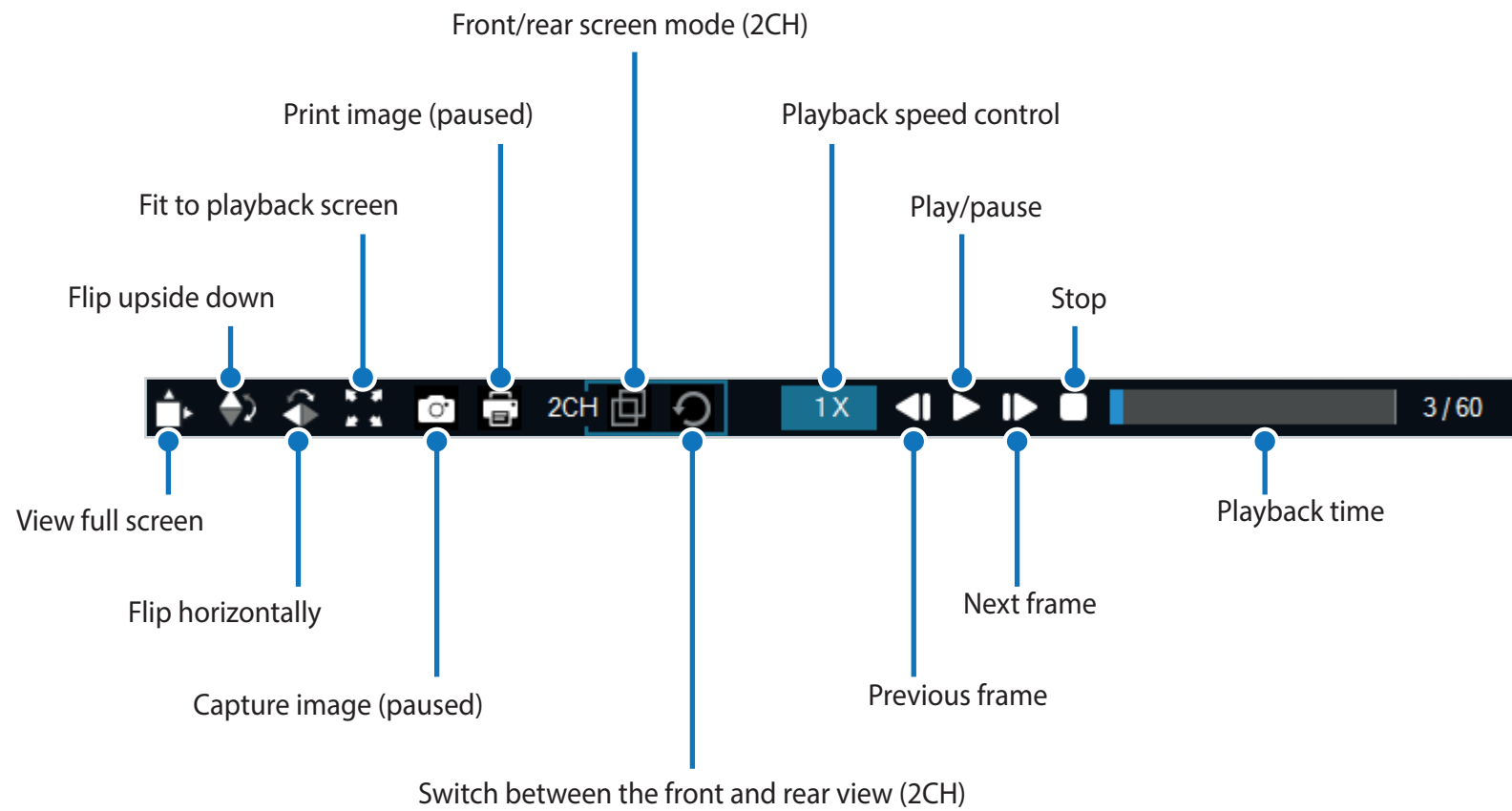

□ Exploring the timeline and G-Sensor graph

You can explore the timeline for the playback of the recorded videos by date, hour, minute and second using the timeline.

You can check the impact sensitivity (G-Sensor) information in the line graph.

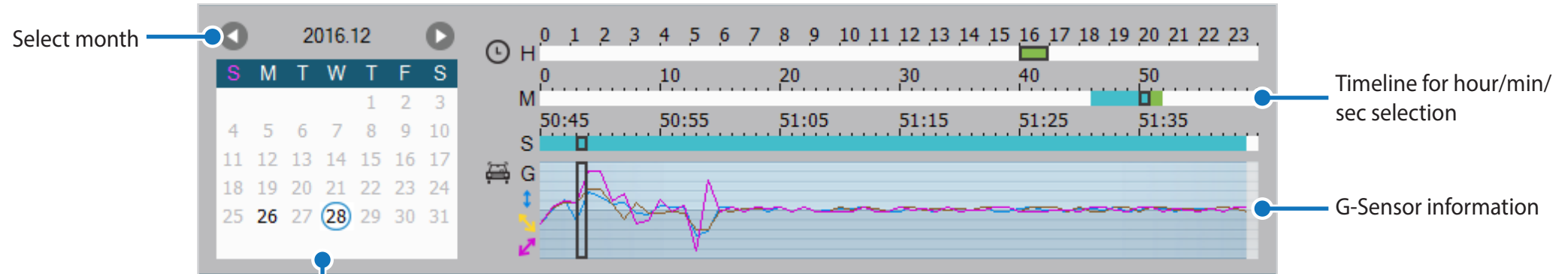

Zoom options

- Use the mouse scroll wheel zoom. Right clicking will restore the video to the default size.
- You can resize the playback frame or the BlackVue Viewer window by dragging the borders.
- **Full-screen view:** Double click on the video image to enter full-screen view. Double click again or tap ESC to return to the default view.

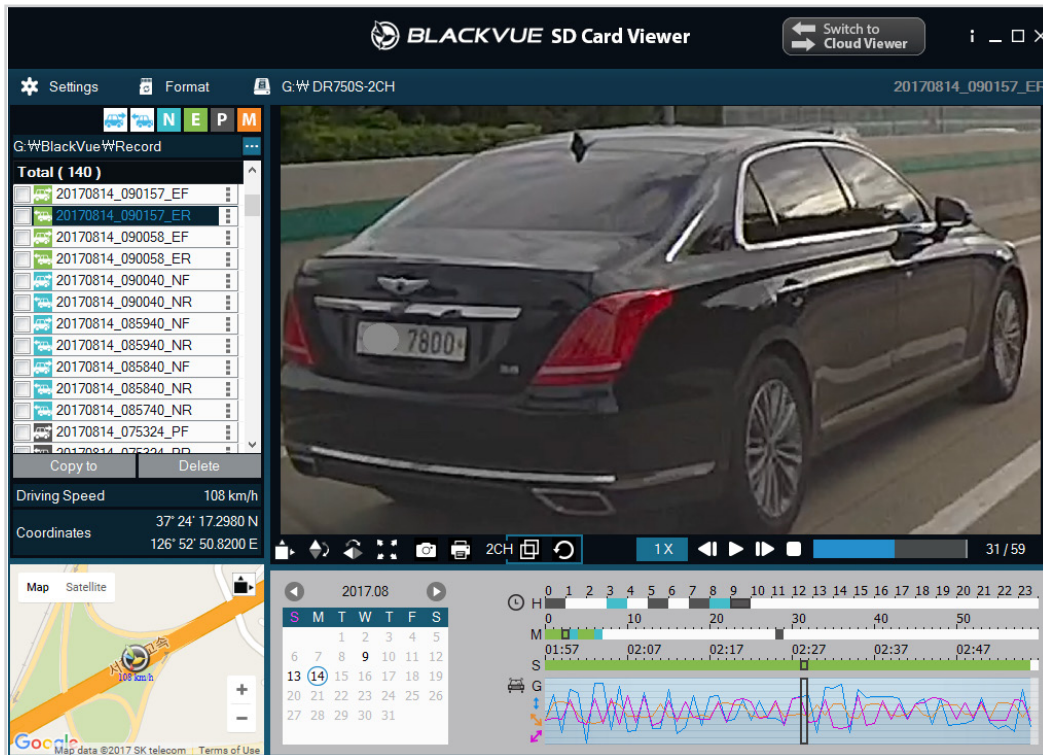

Windows

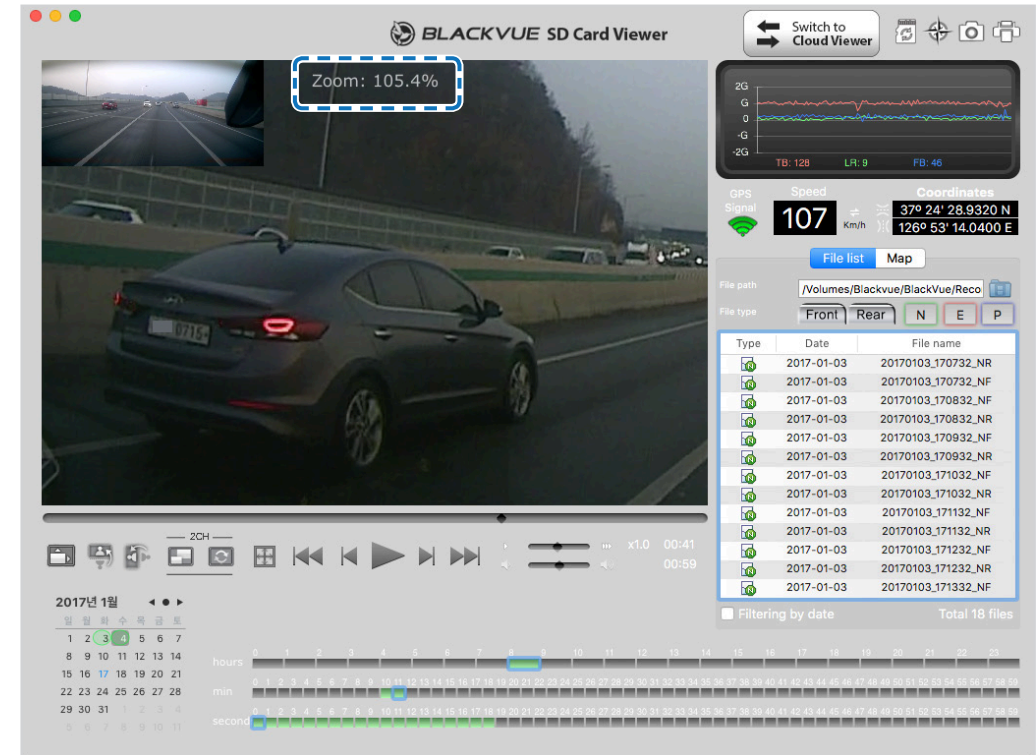

Mac

☐ Checking the GPS data

You can check the GPS data of the recorded video in BlackVue Viewer while video is playing back. The driving speed and coordinates are displayed above the map frame.

📝 Note

- GPS data is not recorded during parking mode. Map data cannot be displayed for parking mode recordings.

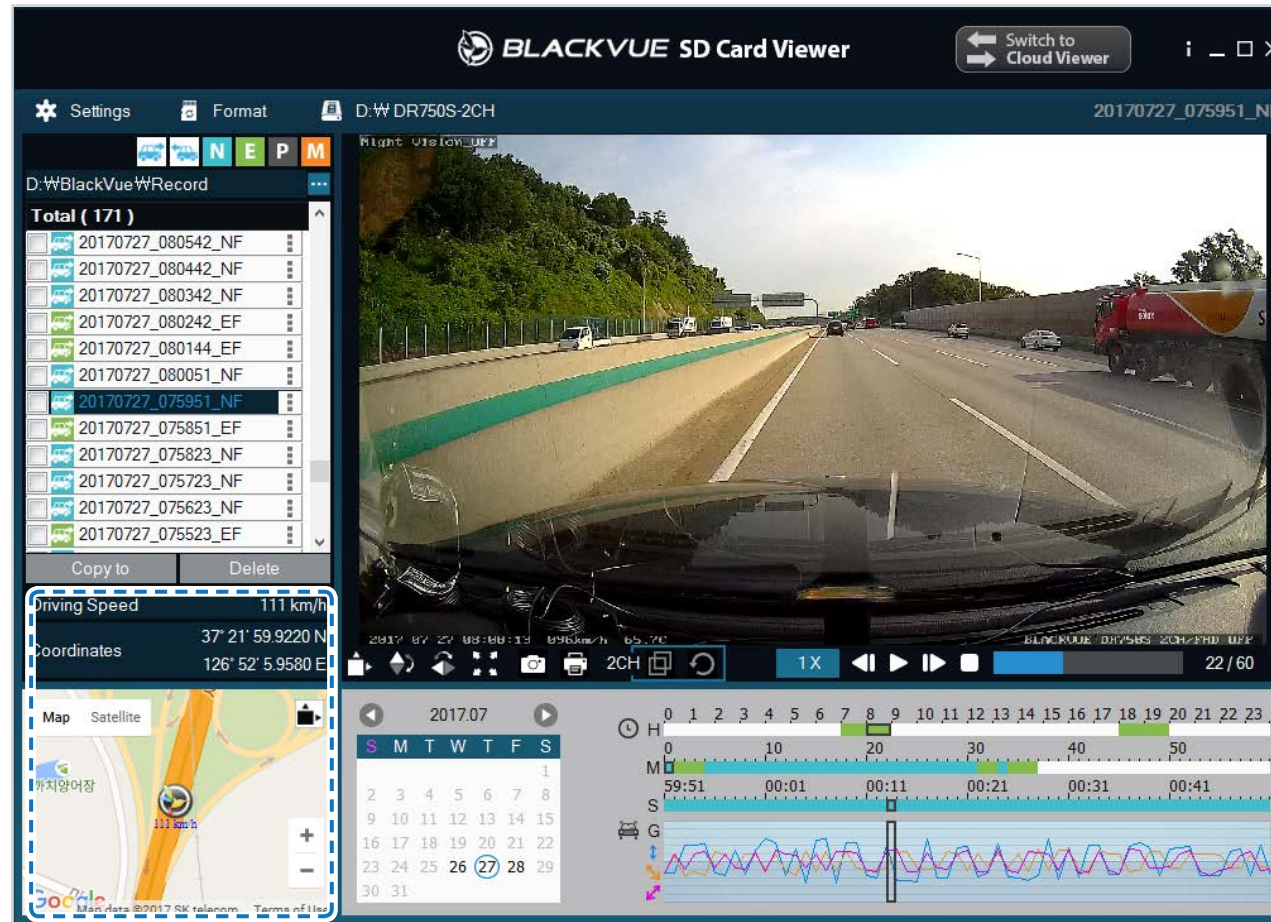



Managing videos

You can manage the recorded videos through the BlackVue Viewer program. You can also format the microSD card.

Note

- If the microSD card is full, by default the dashcam will record over the oldest videos first.

Capturing or printing a still image from video

- 1 Double click a file in the file list to play.
- 2 Click the  pause button to pause the video.
- 3 Select the  capture button to capture the image or the  print button to print directly.

Deleting videos

For Windows users

- 1 Select the video, or videos using the checkboxes, from the recorded video list.
- 2 Click **Delete**.
 - You can also delete individual files by clicking  next to a video in the recorded video list and selecting **Delete**.

■ For Mac users

- 1 Go to \BlackVue\Record\.
- 2 Select the video from the recorded video list.
- 3 Click Move to Trash.

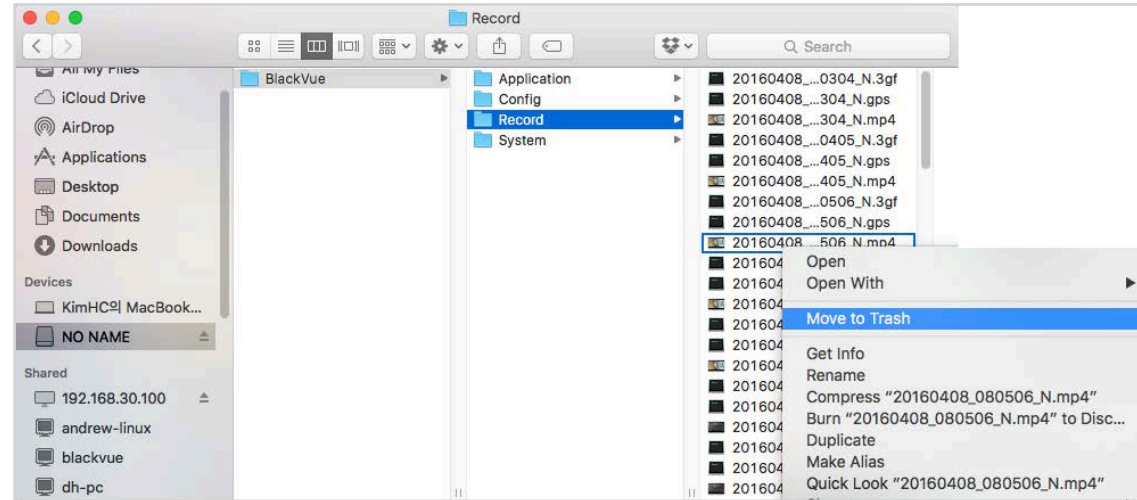

Exporting videos

For Windows users

1 Click  next to a video in the recorded video list.

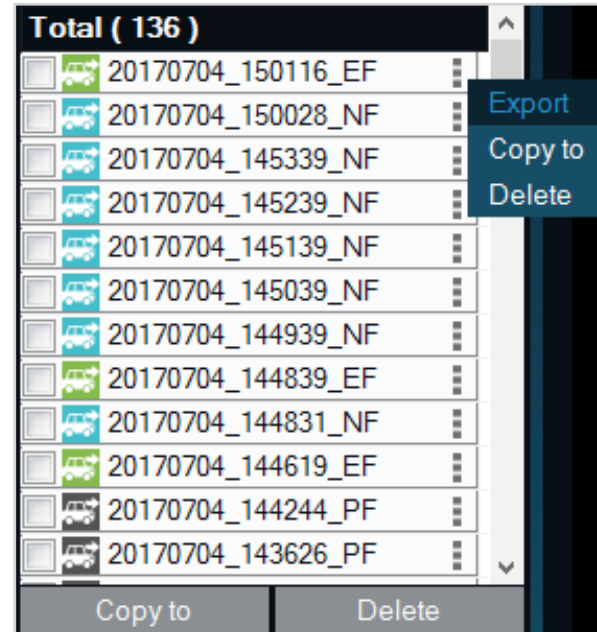

2 Click **Export**.

3 If you want to extract a segment of a file select **Save segment** and edit the start and end second points. To export without audio select **Sound Off**.

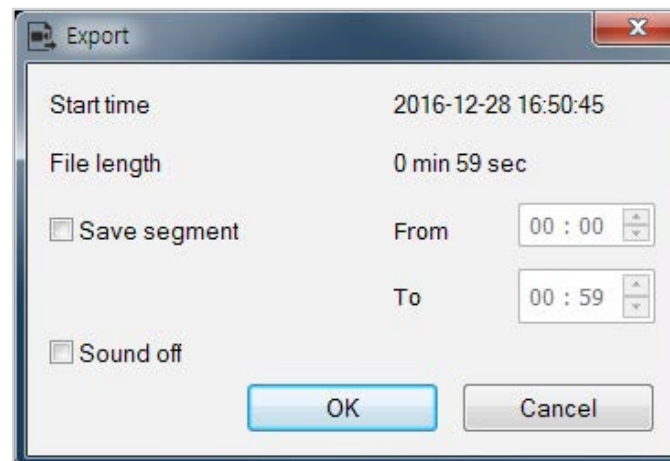

4 Click the **OK** button.

5 Select the folder in which to save the file and enter the file name.

6 Click the **Save** button.

Copying videos

For Windows users

1 Click  next to a video in the recorded video list.

2 Click **Copy to**.

3 Select the folder in which to copy the file and enter the file name.

4 Click the **Select folder** button.

- To copy multiple files at once check the boxes next to the file names and press the **Copy to** button
- When copying files the segment adjustment and sound off tools are not available.

■ For Mac users

- 1 Go to \BlackVue\Record\.
- 2 Select the video from the recorded video list.
- 3 Click Copy "*file name*".

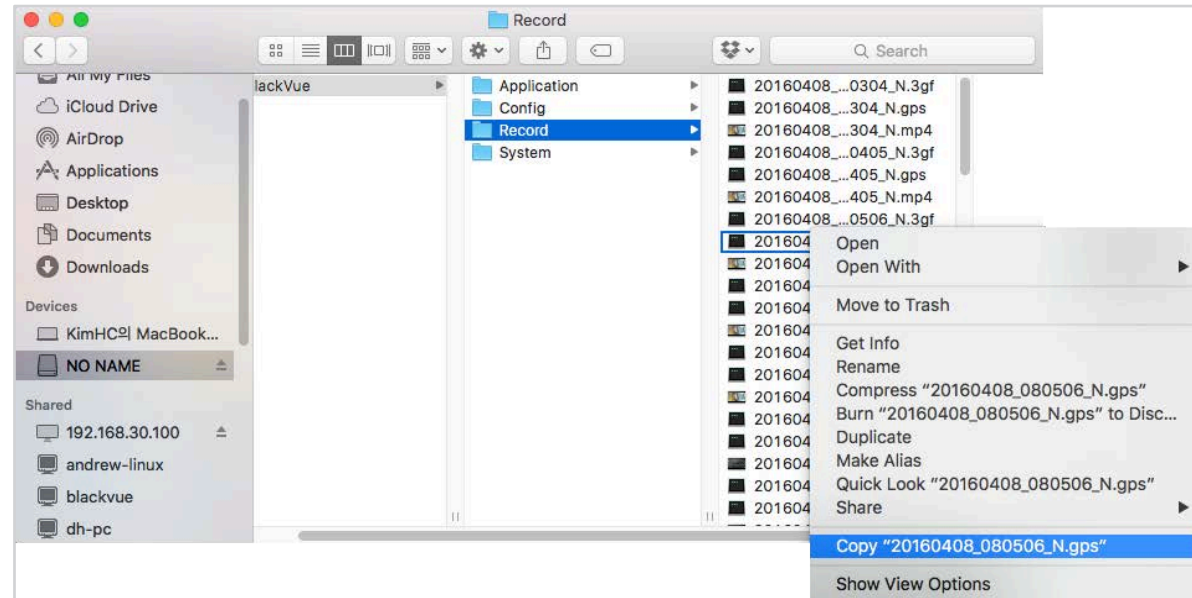

Tips for optimal performance

▶ Formatting the microSD card

⚠ Caution

- Back up necessary video files before formatting the microSD card. If you format the microSD card, all the video files stored in the microSD card will be deleted including the locked event files. Your saved settings will not be affected.

➤ Formatting the card in the BlackVue

Press and hold the Wi-Fi button for 5 seconds and once voice instructions start, release the button. Then press and hold again for 5 seconds to format the SD card.

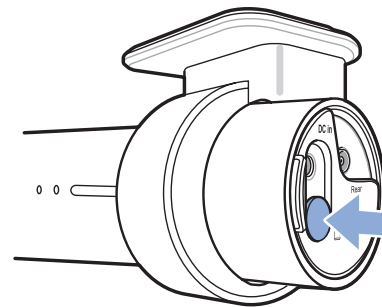

➤ Format using BlackVue Viewer (Windows)

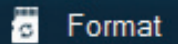
- 1 Insert the microSD card into the microSD card reader and connect the reader to your computer.
- 2 Download **BlackVue Viewer (Windows)** from www.blackvue.com > **Support** > **Downloads** and install it on your computer.
- 3 Launch the **BlackVue Viewer** that is installed on your computer.
- 4 Click the  **Format** button, select the card drive and click OK.

➤ Format using BlackVue Viewer (macOS)

- 1 Insert the microSD card into the microSD card reader and connect the reader to your computer.
- 2 Download **BlackVue Viewer (Mac)** from www.blackvue.com > **Support** > **Downloads** and install it on your computer.
- 3 Launch the **BlackVue Viewer** that is installed on your computer.
- 4 Click the  Format button and select the microSD card from the list of drives in the left frame.

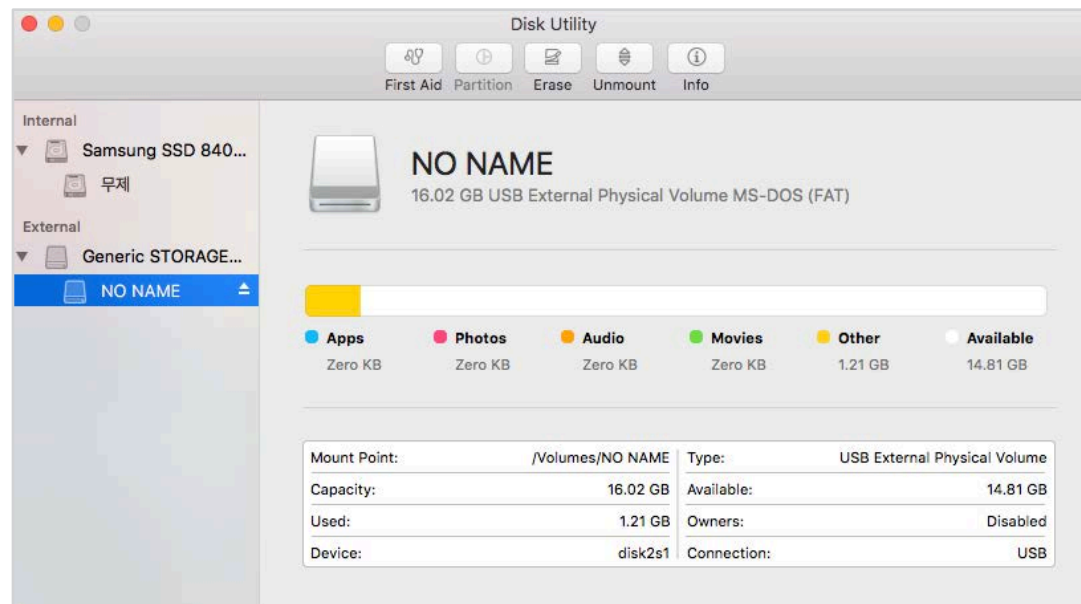

5 After selecting your microSD card select the Erase tab in the main window.

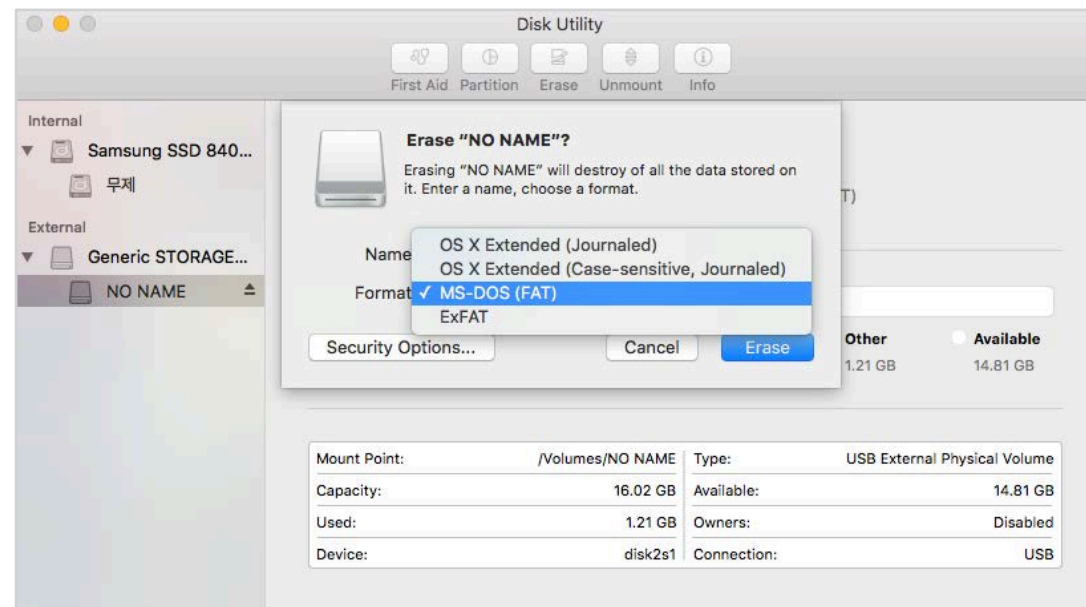

6 Select "MS-DOS (FAT)" from the Volume Format drop-down menu and click Erase.

Note

- Formatting the microSD card once a month is recommended.
- Format the microSD card if the recorded video quality appears to be poor.
- Only use official BlackVue microSD cards. Other cards may have compatibility issues. PittaSoft Co., Ltd. will not be held responsible for any problems caused by using another manufacturer's microSD card.
- For Windows users: To format the microSD card directly from "My Computer", right-click the microSD card drive and select Format. Select File system as FAT32 and Allocation unit size as 64KB then click Start. If FAT32 is not available or can't be selected, please format the microSD card using BlackVue Viewer.

Upgrading the firmware

Regularly upgrade the firmware for performance improvements and updated features. Firmware updates will be made available for download at www.blackvue.com > **Support** > **Downloads**.

Your saved settings are not affected by firmware upgrade.

Upgrading the firmware using an iOS or Android device (Firmware Over The Air)

[Click here for a step-by-step video tutorial](#), or go to the main menu and select **Help** > **Video tutorials**.

Makes sure your smartphone has a stable internet connection.

- 1 Open the BlackVue app
- 2 Tap  and select **Firmware download**.
- 3 Select your dashcam model and the firmware language and tap **OK**.

Note

- Please select the firmware language currently installed in your dashcam. Once upgrade is completed, you can change the firmware language from dashcam settings as described on page **70** or **73**.

- 4 Check the firmware version and release notes and tap **OK** to start downloading.
- 5 After the download completes tap **OK** to be taken back to the home screen.

Make sure your BlackVue dashcam is on and nearby.

6 Go to your smartphone's **Settings** then select **Wi-Fi**, and make sure Wi-Fi is turned on.

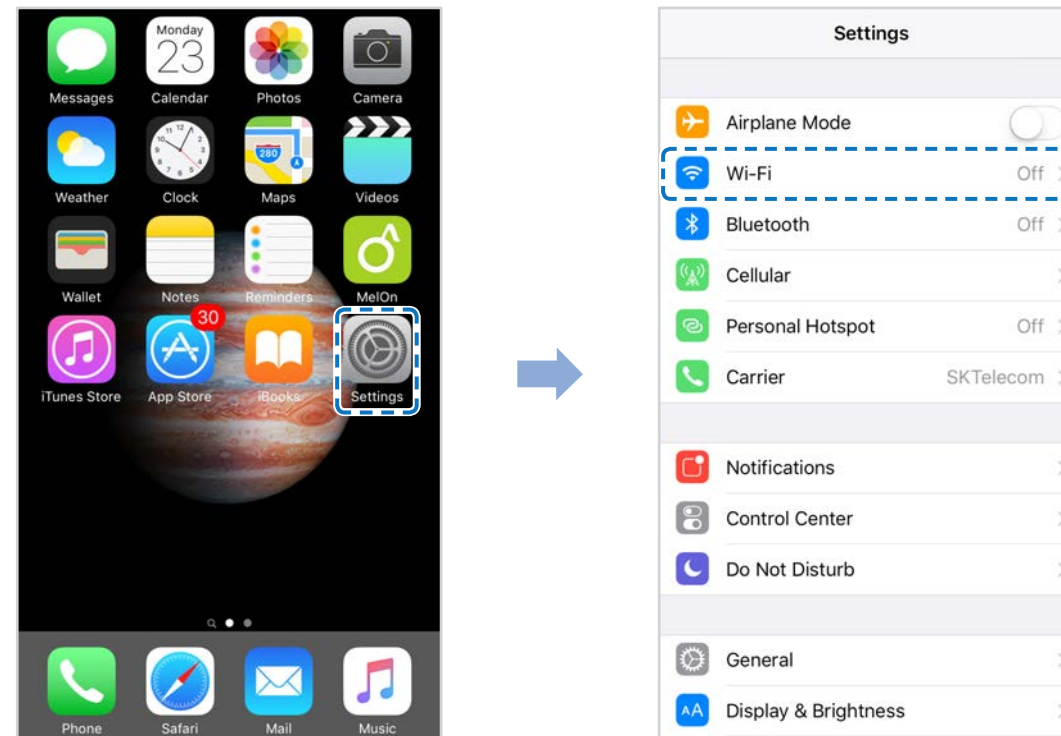

7 Choose your BlackVue dashcam from the network list. The dashcam's default SSID begins with its model number (e.g. BlackVue750S-*****).

8 Enter the password and tap join.

* The default Wi-Fi SSID and password is labeled on the dashcam. To find them, unplug the cables and remove the front camera from its mount.

9 Open the BlackVue app. Select **BLACKVUE WI-FI** >  > **Firmware upgrade**.





10 Tap **OK** to apply the firmware upgrade.

11 The dashcam's firmware will be upgraded – this may take a few minutes. The dashcam needs to reboot to complete the firmware upgrade.

➤ Upgrading the firmware using a computer (Windows or Mac)

Keep your BlackVue dashcam updated by upgrading the firmware to the latest version. Visit the BlackVue website (www.blackvue.com) to check for any new firmware releases for your BlackVue dashcam model.

- 1 Insert the microSD card into the microSD card reader.
- 2 Connect the microSD card reader to a computer.
- 3 Launch BlackVue Viewer and click on the About  button.
 - For Mac users, click  **BlackVue Viewer** and select About BlackVue from the menu.
- 4 Check the current firmware version of your BlackVue dashcam and proceed only if your version is not the latest one.

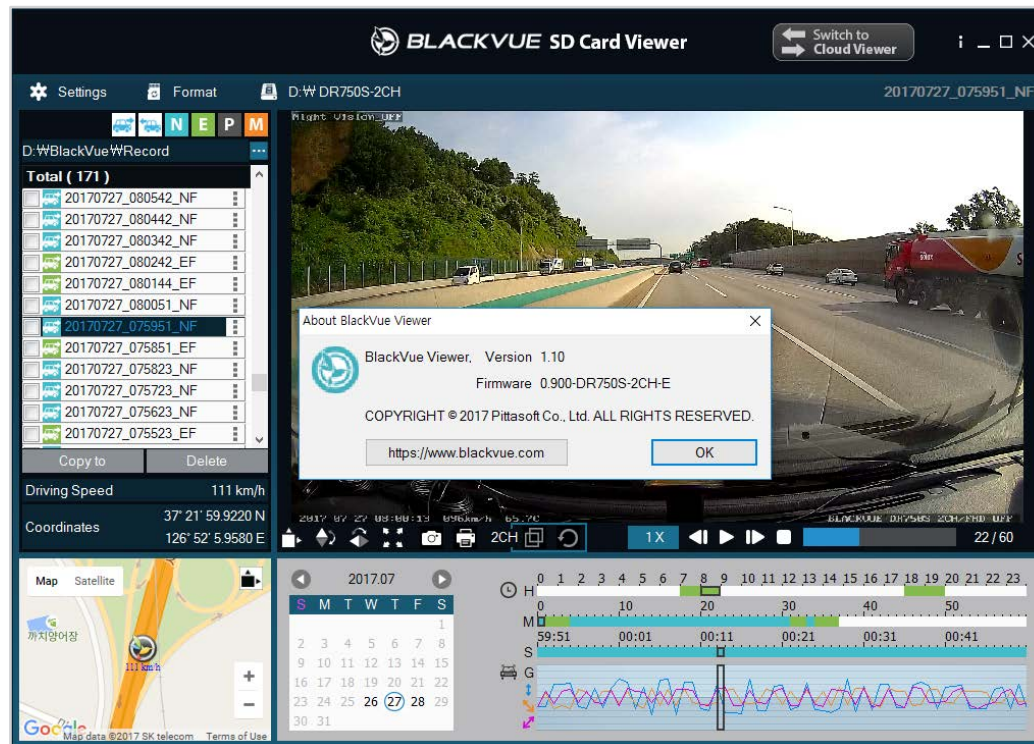

Windows

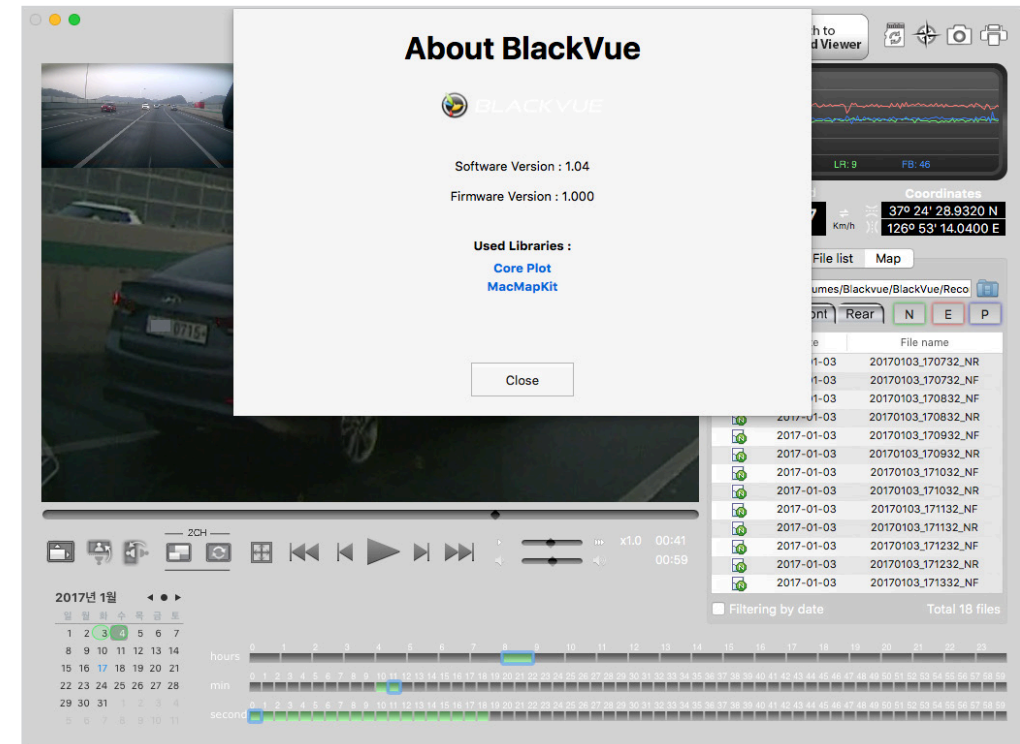

Mac

- 5 Format the microSD card. See **"Formatting the microSD card"** on page 44.

- 6 Go to the BlackVue website (www.blackvue.com > Support > Download) and download the latest firmware for your BlackVue dashcam model in zip format.
- 7 Unzip the downloaded file and copy the BlackVue folder to the microSD card.

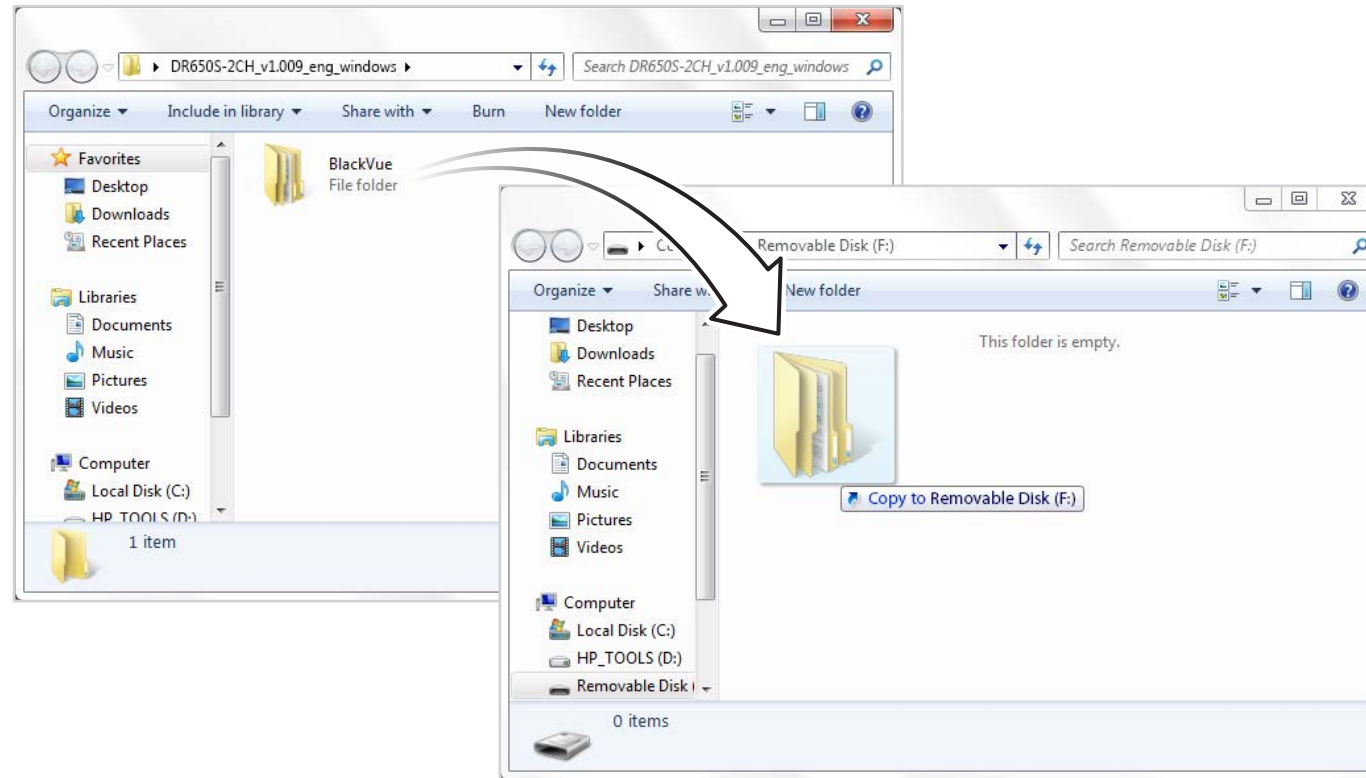

- 8 Insert the microSD card into the dashcam and connect the power to initiate the firmware upgrade. Make sure the power remains on until the upgrade is completed. Any power interruption may prevent the firmware upgrade from completing, resulting in malfunction.

Note



- Do not insert or remove the microSD card when the dashcam is turned on. Doing so may damage the data and cause a malfunction of the microSD card.
- Your saved settings are not affected by firmware upgrade.
- The firmware is upgraded to the previously saved language. If you want to change it, please refer to page **70** or **73**.

Changing settings

▶ Changing settings using your smartphone (Android/iOS)



“Pair” your smartphone with the BlackVue dashcam via direct Wi-Fi (for details see **"Opening video files" on page 18**).

- 1 Go to your smartphone's **Settings** > **Wi-Fi** and connect to your dashcam.
- 2 Open the BlackVue app. Select **BLACKVUE WI-FI** >  to access the Firmware settings menu.
- 3 After making any changes, go back to the Firmware settings menu, tap  and tap **Save and close**.

Caution

- Please backup necessary recordings before changing **time, video resolution, image quality** or **video segment length** settings. If any of the aforementioned settings are changed and saved, the dashcam will format the microSD card and delete all recordings stored on the card including locked event files in order to ensure optimal performance.

Basic settings

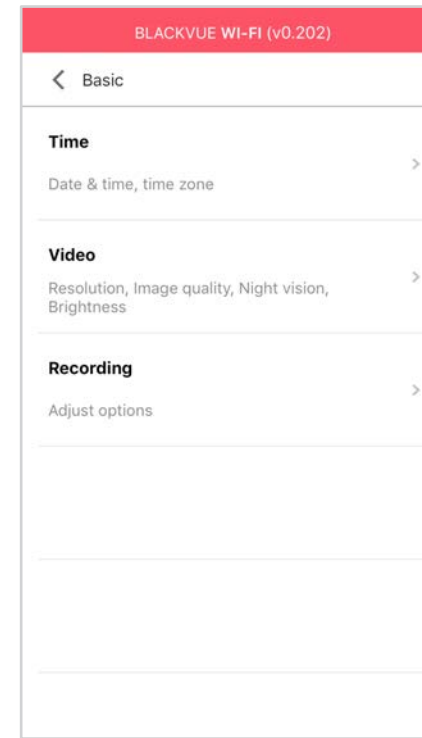
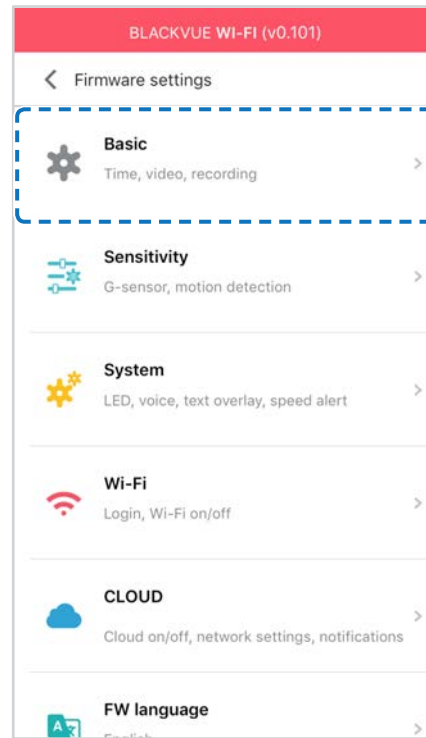

Time settings

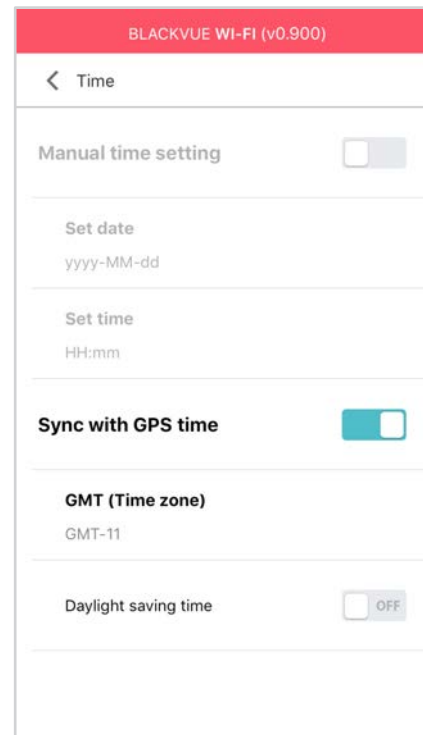

Select your time zone to auto-sync with GPS time or you can set the time and date manually after enabling **Manual time setting**.

 **Note**

- The factory setting is GMT -11.

Some examples of GMT time offsets are:

- GMT-7: Los Angeles
- GMT-4: New York
- GMT+0: London
- GMT+1: Paris
- GMT+3: Moscow
- GMT+8: Singapore
- GMT+9: Seoul
- GMT+10: Sydney

If you are unsure of your GMT offset please look up your city on <https://greenwichmeantime.com/>

*Selecting **Daylight saving time** will advance the clock by one hour.

- When setting the time manually, please set to the expected time you will use the BlackVue (not the present time).

Video settings

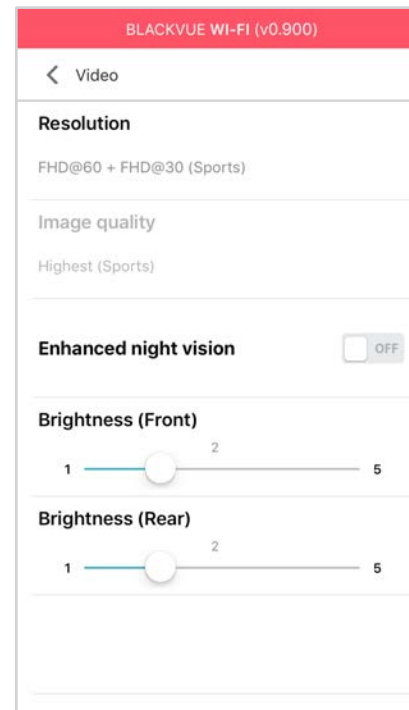

Resolution

Select the resolution and frame rate. For example, "FHD@30 + FHD@30" means the front camera records Full HD video at 30 frames per second, and the rear camera records Full HD video at 30 frames per second.

Note

- At "FHD@60+FHD@30" resolution , the image quality is automatically set to Highest and Video segment length to 1 min. These settings can not be changed.

Image quality

You can adjust the recording image quality (bit rate). Choose between:

- Highest (Front: 12 Mbit/s, Rear: 10 Mbit/s)
- High (Front: 10 Mbit/s, Rear: 8 Mbit/s)
- Normal (Front: 8 Mbit/s, Rear: 6 Mbit/s)

These are the maximum bit rates when the resolution is set to "FHD@30 + FHD@30". If you lower the resolution and frame rate setting, the actual bit rates will be lower.

Increasing the image quality will increase the size of the video files. Loading and copying time will increase accordingly.

■ **Enhanced night vision**

The dashcam has intrinsic night vision feature. If you want to enhance it, enable Enhanced night vision.

■ **Brightness (Front)**

You can adjust the recording brightness level of the front camera.

■ **Brightness (Rear)**

You can adjust the recording brightness level of the rear camera.

Recording settings

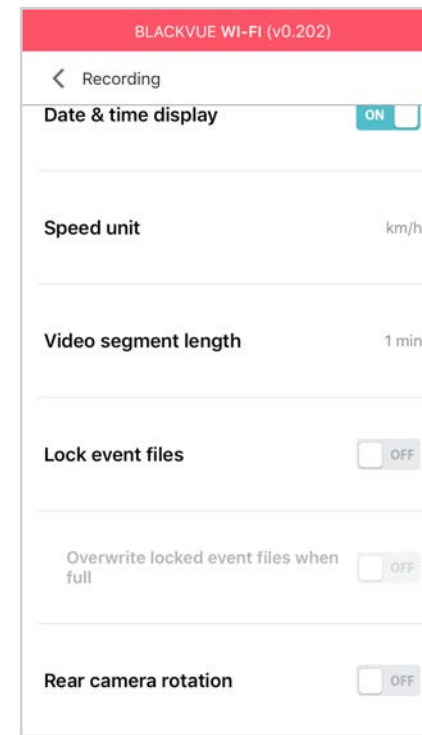
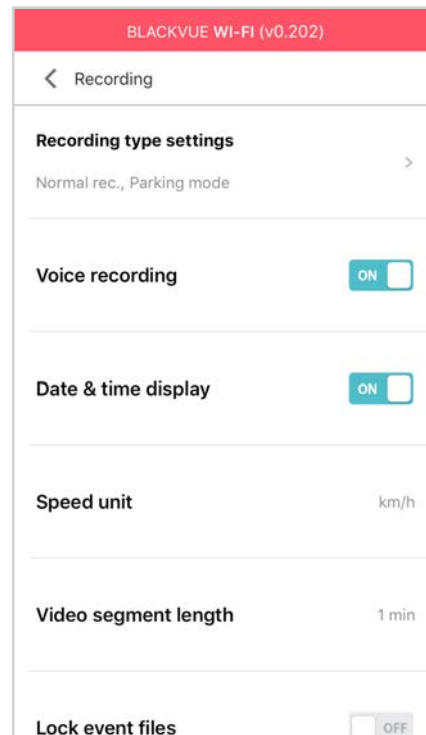

Recording type settings

Normal recording

When turned off the dashcam does not record in normal mode.

Automatic parking mode

If enabled, the dashcam switches from normal mode to parking mode when the vehicle is stationary for 5 minutes.

Voice recording

When turned off the dashcam does not record audio.

Date & time display

Turn on/off the date and time display on videos.

Speed unit

Select km/h, MPH, or turn off.

Video segment length

Choose between 1, 2 or 3 minute video segment lengths.

Lock event files

Turning on this option will lock the following recording types and stop them from being overwritten by newer recordings:

- Impact event recordings during normal and parking mode (E); and
- Manual recordings (M).

A maximum of 50 files can be locked. Once this limit is reached, to lock new recordings please review locked files on the microSD card and free up space, or enable 'Overwrite locked event files when full' to allow the oldest locked files to be overwritten.

Rear camera rotation

If you installed the rear camera in a flipped position, use this setting to rotate the rear camera image 180°.

Sensitivity settings

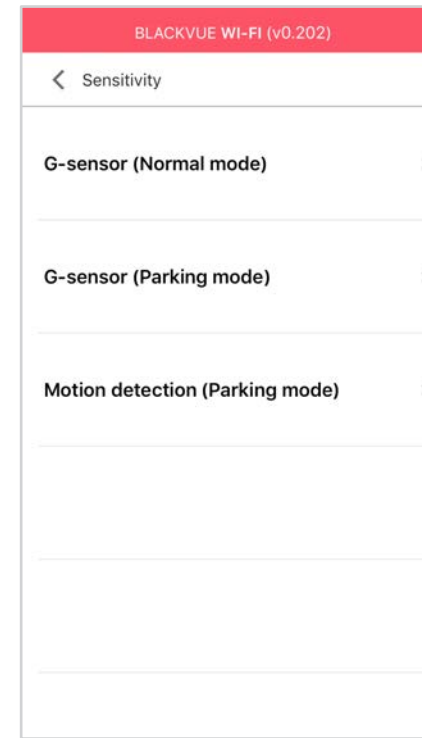
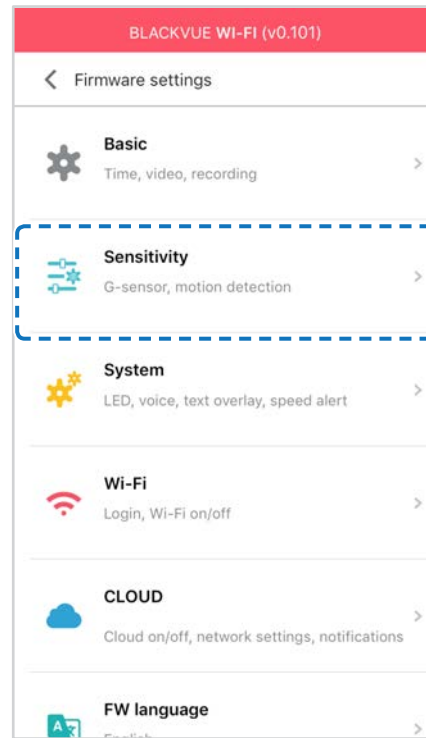

G-Sensor (Normal mode) / G-Sensor (Parking mode)

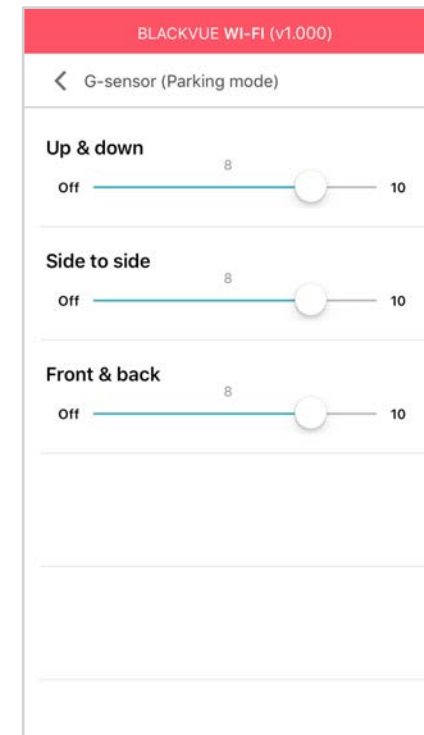
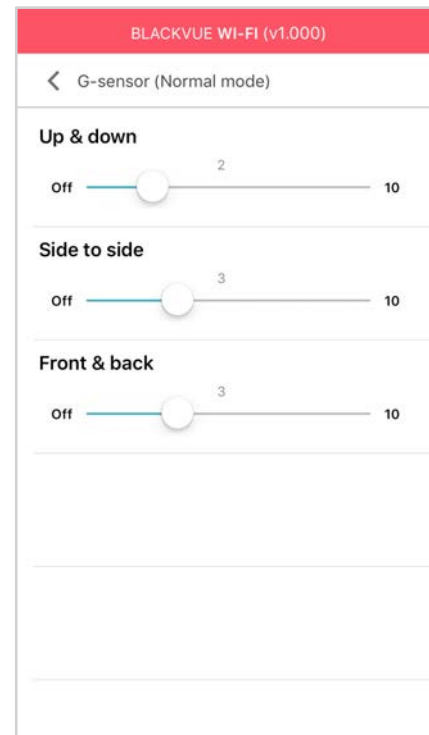

The G-sensor measures the movement of your vehicle through 3 axes – up and down, side to side, and front and back. When the G-sensor detects significant or sudden movement (such as an impact or collision) it will trigger an event recording. You can adjust the sensitivity so minor incidents and bumps don't trigger an event recording. To turn off event recordings by impact detection set the G-sensor sensitivity to off.

Motion detection (Parking mode)

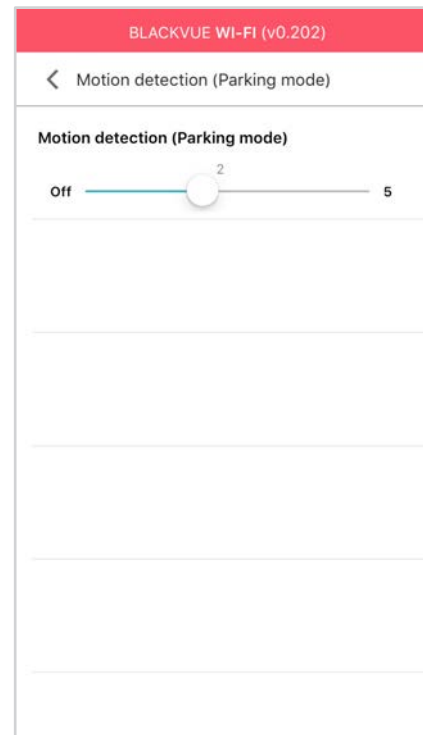

In parking mode the dashcam continuously buffers video and saves a parking recording when motion is detected in the dashcam's field of view.

You can adjust the sensitivity of the motion detection so minor motion caused by wind or rain doesn't trigger a recording. Please take into account your vehicle's surroundings when adjusting the sensitivity.

➤ System settings

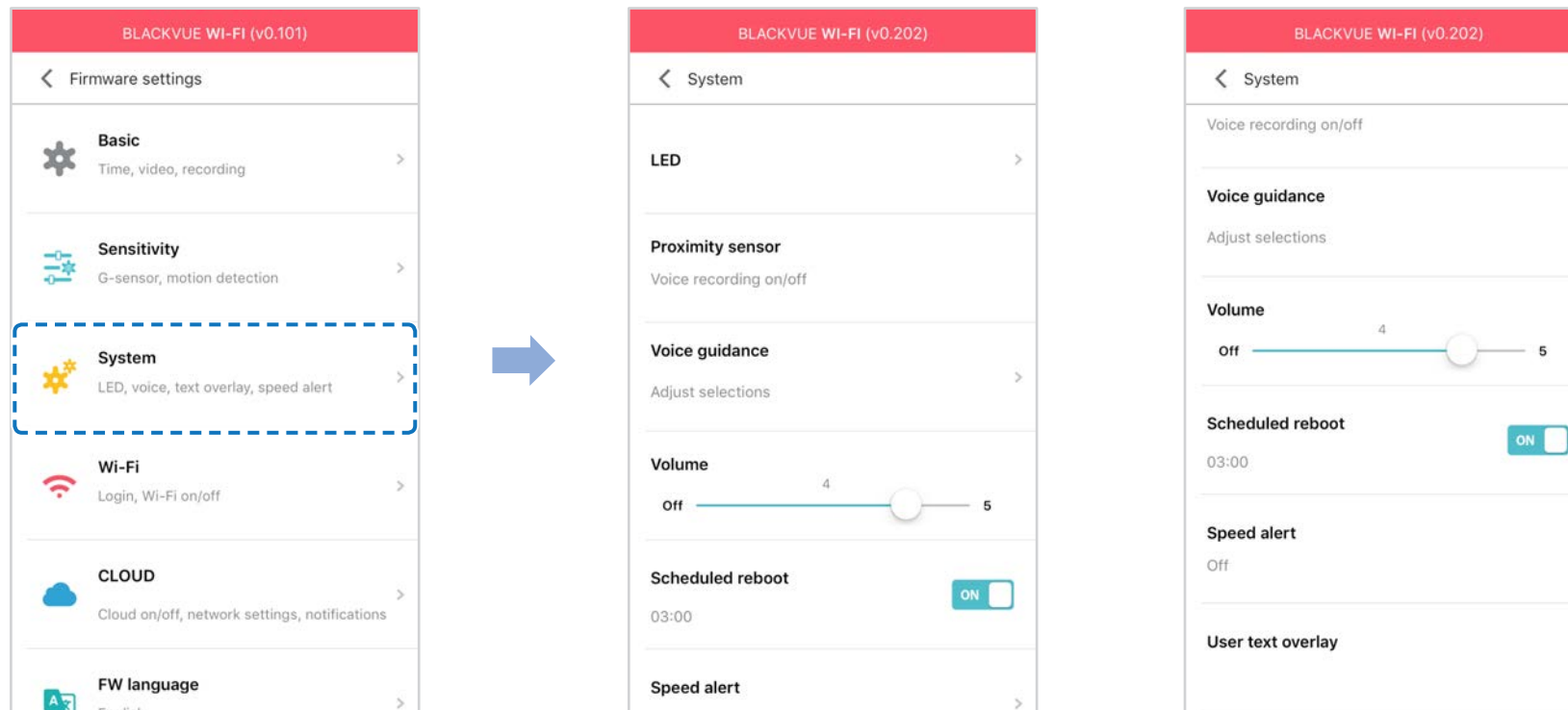

LED

Recording status

You can turn the recording status LED on/off.

Front security (Normal mode)

You can turn the front security LED on/off for normal mode.

Front security (Parking mode)

You can turn the front security LED on/off for parking mode.

Rear security

You can turn the rear security LED on/off.

Wi-Fi (Parking mode)

You can turn the Wi-Fi LED on/off for parking mode.

Proximity Sensor

You can choose the function of proximity sensor. It can be configured either for audio recording on/off feature or to trigger manual recording.

Voice guidance

You can adjust the voice guidance (announcements) you want to hear.

Volume

You can adjust the volume of the voice guidance (announcements).

Scheduled Reboot

The dashcam reboots automatically once-a-day if in parking mode at the set time for improved stability. If the dashcam is recording at the set time, the scheduled reboot is skipped.

You can enable/disable and change the time for scheduled rebooting. Default time is 03:00 am.

Speed alert

Set a speed limit (up to 300 km/h or 200 MPH) for the speed alert. When the vehicle exceeds the specified speed limit, the dashcam beeps and switches to event recording. After saving one event recording file the dashcam switches back to normal mode recording.

User text overlay

You can create a user text overlay of up to 20 characters using a combination of English letters (A – Z, a – z), numbers (0 – 9), and symbols (;:/+_-)\$#). The text is overlaid in the top-left corner of the recorded videos.

➤ Wi-Fi settings

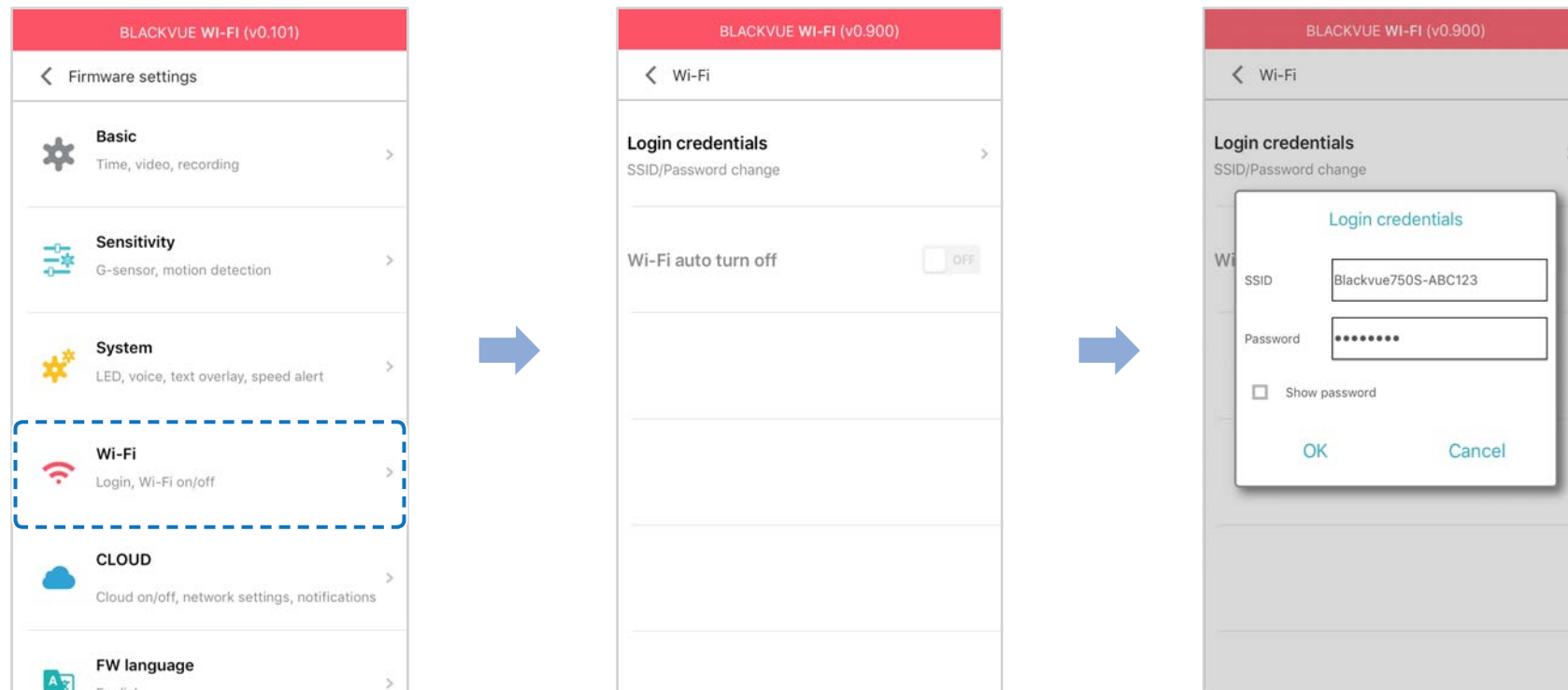

☐ Login credentials

You can change the dashcam's SSID and Wi-Fi login password.

☐ Wi-Fi auto turn off

When the Cloud service is enabled the Wi-Fi auto turn off setting cannot be adjusted. Wi-Fi will automatically switch on when you turn on the dashcam and remain on.

If you disable the Cloud service, you will be able to adjust the Wi-Fi auto turn off setting.

	ON	OFF
Wi-Fi auto turn off	Wi-Fi turns off if it is inactive for 10 minutes.	Wi-Fi does not turn off automatically.

Cloud settings

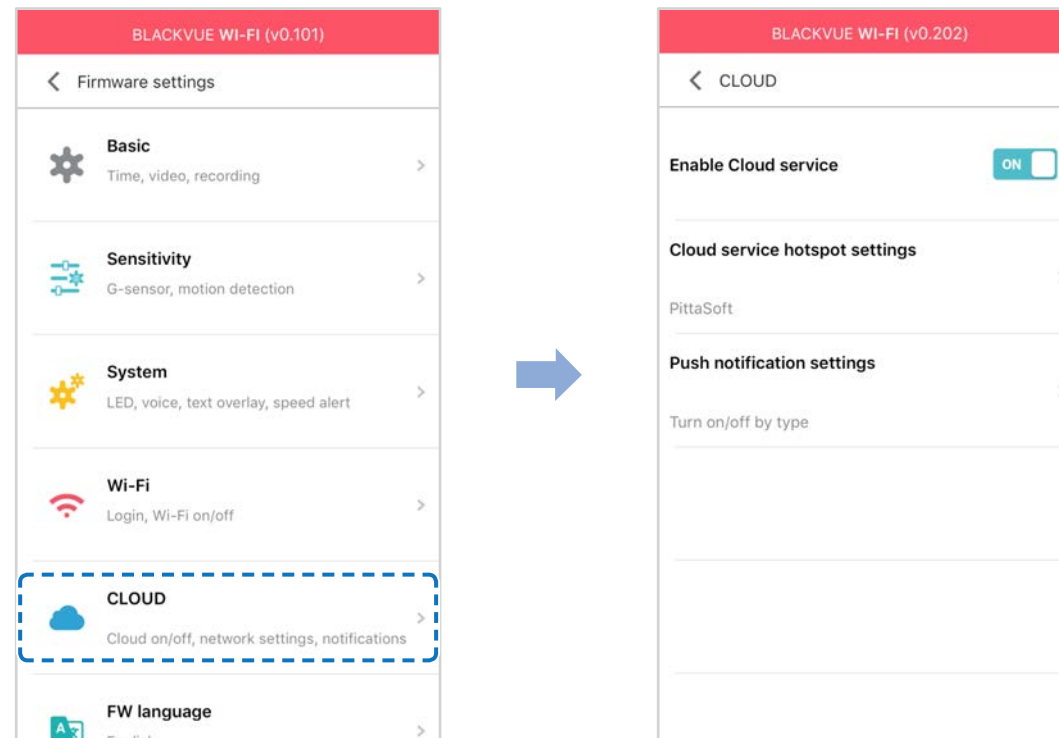

Enable Cloud service

If you don't use the Cloud service you can turn it off.

Cloud service hotspot settings

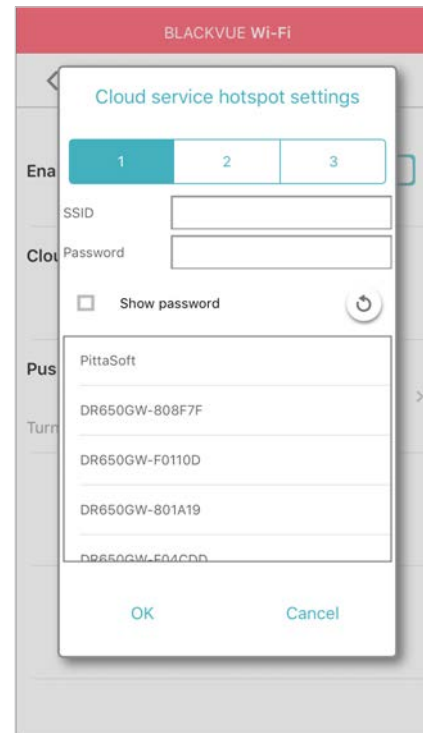

Up to 3 Wi-Fi hotspot SSIDs can be saved (e.g. home, portable hotspot and work). Choose your Wi-Fi hotspot from the list and enter the password. Tap 2 and 3 to add settings for additional hotspots.

Your BlackVue will try to connect to hotspot 1 first. If it cannot connect to hotspot 1, it will then try to connect to hotspot 2, and then hotspot 3.

Note

- The BlackVue DR750S-1CH, DR750S-2CH is not compatible with 5GHz wireless networks.

Push notification settings

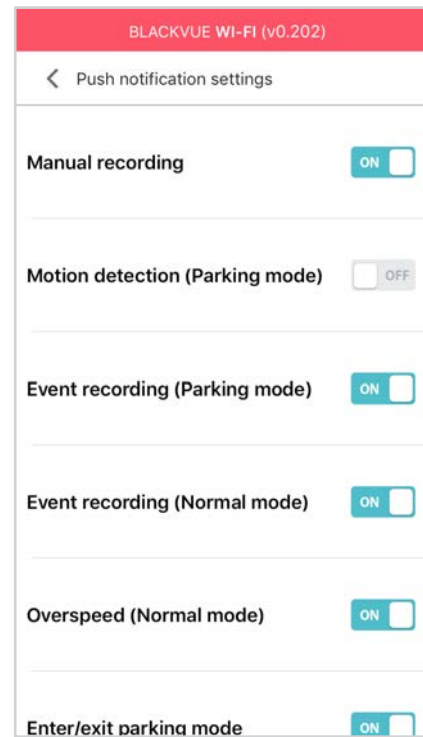

You can customize when you want to receive push notifications.

FW Language

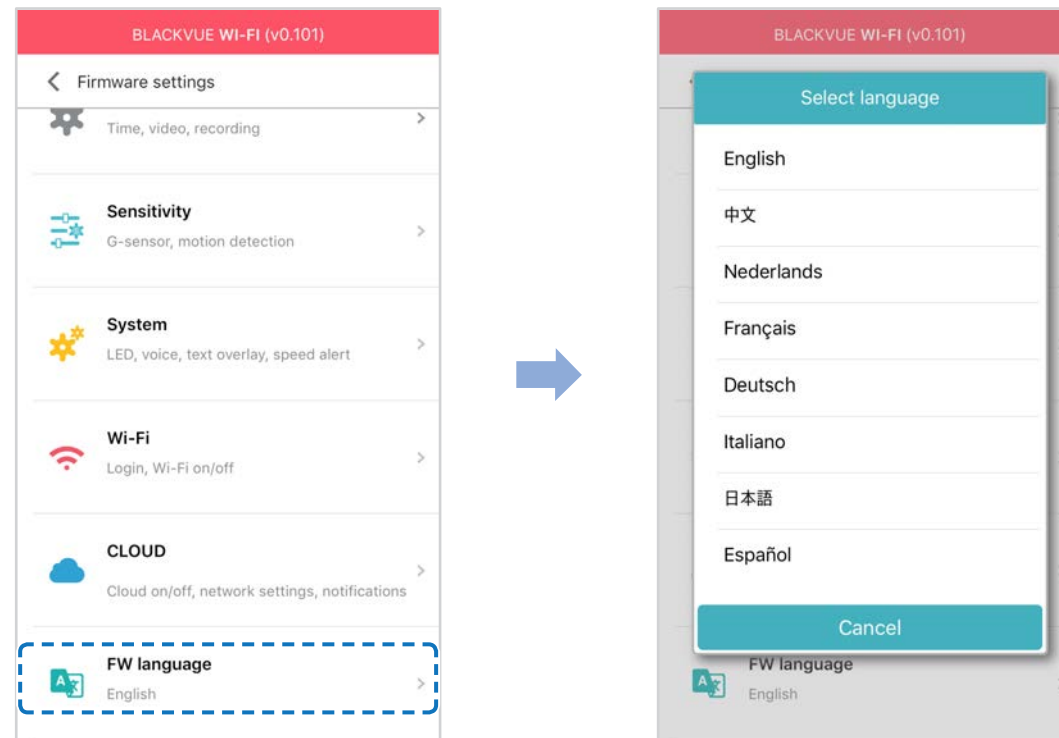

You can change the Firmware language of your dashcam.

▶ Changing settings using your computer (Windows/Mac)

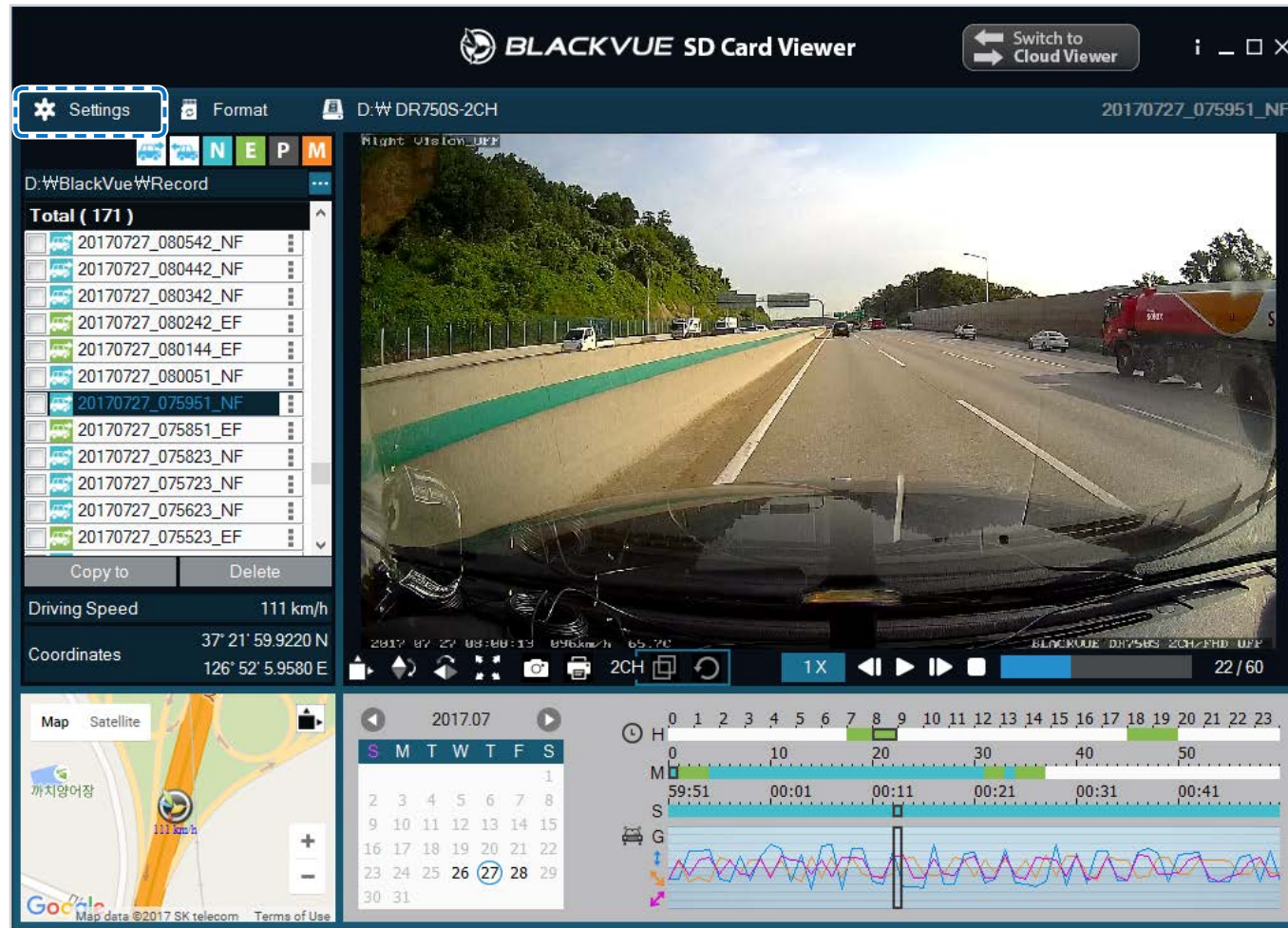

Click on the **Settings** button (Windows) or the **BlackVue Viewer** menu (mac OS) to open the BlackVue settings panel. You will be able to change most of the BlackVue settings to customize its operation.

BlackVue Viewer settings

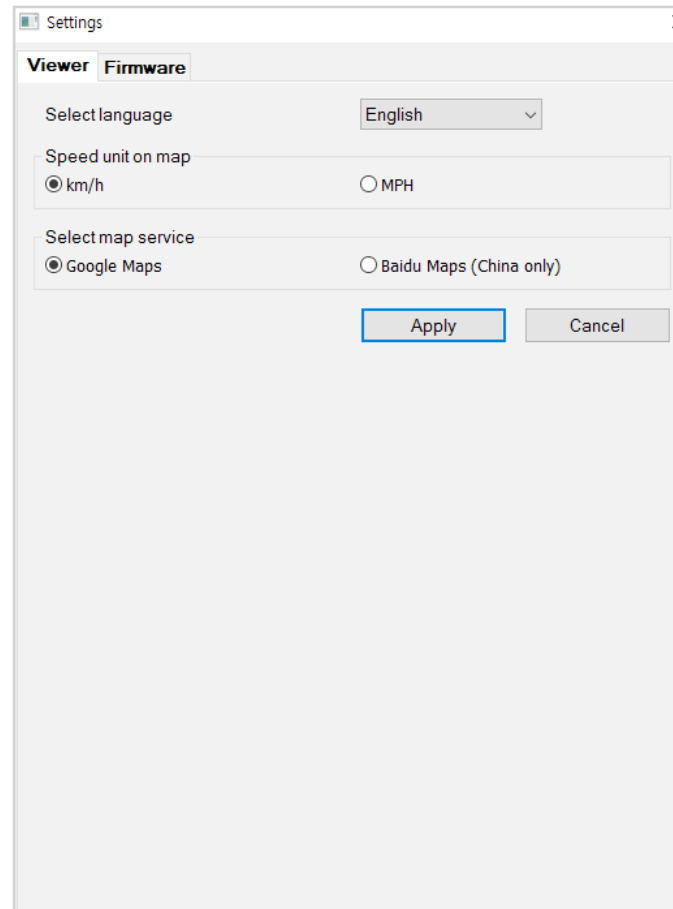

Select language

Select your preferred language for the BlackVue Viewer interface from the dropdown list.

Speed unit on map

Change the speed unit displayed on the map.

Select map service

Change the mapping service used.

Firmware settings

Select your preferred language for the firmware from the FW language dropdown list. The audio announcements by the dashcam will be in the selected language.

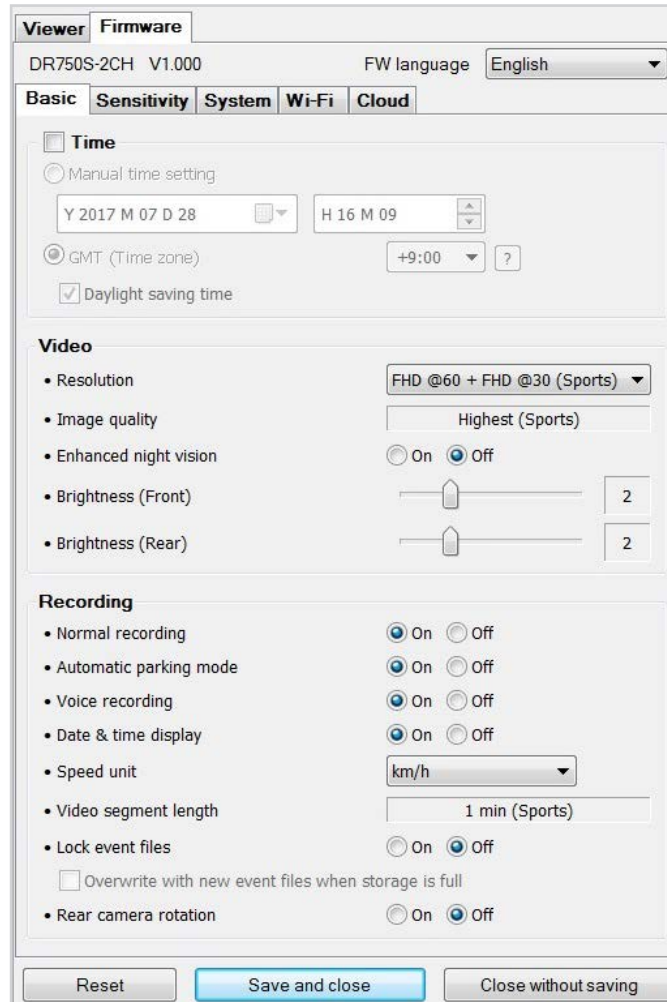

Viewer **Firmware**
DR750S-2CH V1.000 FW language English

Basic **Sensitivity** **System** **Wi-Fi** **Cloud**

Time

Manual time setting
Y 2017 M 07 D 28 H 16 M 09

GMT (Time zone) +9:00 ?

Daylight saving time

Video

- Resolution: FHD @60 + FHD @30 (Sports)
- Image quality: Highest (Sports)
- Enhanced night vision: On Off
- Brightness (Front): 2
- Brightness (Rear): 2

Recording

- Normal recording: On Off
- Automatic parking mode: On Off
- Voice recording: On Off
- Date & time display: On Off
- Speed unit: km/h
- Video segment length: 1 min (Sports)
- Lock event files: On Off
- Overwrite with new event files when storage is full
- Rear camera rotation: On Off

Reset Save and close Close without saving

Caution

- Please backup necessary recordings before changing **time**, **video resolution**, **image quality** or **video segment length** settings. If any of the aforementioned settings are changed and saved, the dashcam will format the microSD card and delete all recordings stored on the card including locked event files in order to ensure optimal performance.

Basic settings

Time settings

Select your time zone to auto-sync with GPS time or you can set the time and date manually after enabling **Manual time setting**.

 **Note**

- The factory setting is GMT -11.

Some examples of GMT time offsets are:

- GMT-7: Los Angeles
- GMT-4: New York
- GMT+0: London
- GMT+1: Paris
- GMT+3: Moscow
- GMT+8: Singapore
- GMT+9: Seoul
- GMT+10: Sydney

If you are unsure of your GMT offset please look up your city on <https://greenwichmeantime.com/>

*Selecting **Daylight saving time** will advance the clock by one hour.

- When setting the time manually, please set to the expected time you will use the BlackVue (not the present time).

■ Video settings

– Resolution

Select the resolution and frame rate. For example, "FHD@30 + FHD@30" means the front camera records Full HD video at 30 frames per second, and the rear camera records Full HD video at 30 frames per second.

Note

- At "FHD@60+FHD@30" resolution, the image quality is automatically set to Highest and Video segment length to 1 min. These settings can not be changed.
- Frame rate may vary during Wi-Fi streaming.

– Image quality

You can adjust the recording image quality (bit rate). Choose between:

- Highest (Front: 12 Mbit/s, Rear: 10 Mbit/s)
- High (Front: 10 Mbit/s, Rear: 8 Mbit/s)
- Normal (Front: 8 Mbit/s, Rear: 6 Mbit/s)

These are the maximum bit rates when the resolution is set to "FHD@30 + FHD@30". If you lower the resolution and frame rate setting, the actual bit rates will be lower.

Increasing the image quality will increase the size of the video files. Loading and copying time will increase accordingly.

– Enhanced night vision

The dashcam has intrinsic night vision feature. If you want to enhance it, enable Enhanced night vision.

– Brightness (Front)

You can adjust the recording brightness level of the front camera.

– Brightness (Rear)

You can adjust the recording brightness level of the rear camera.

■ Recording settings

– Normal recording

When turned off the dashcam does not record in normal mode.

– Automatic parking mode

If enabled, the dashcam switches from normal mode to parking mode when the vehicle is stationary for 5 minutes.

– Voice recording

When turned off the dashcam does not record audio.

– Date & time display

Turn on/off the date and time display on videos.

– Speed unit

Select km/h, MPH, or turn off.

– Video segment length

Choose between 1, 2 or 3 minute video segment lengths.

– **Lock event files**

Turning on this option will lock the following recording types and stop them from being overwritten by newer recordings:

- Impact event recordings during normal and parking mode (E); and
- Manual recordings (M).

A maximum of 50 files can be locked. Once this limit is reached, to lock new recordings please review locked files on the microSD card and free up space, or enable 'Overwrite locked event files when full' to allow the oldest locked files to be overwritten.

– **Rear camera rotation**

If you installed the rear camera in a flipped position, use this setting to rotate the rear camera image 180°.

□ Sensitivity settings

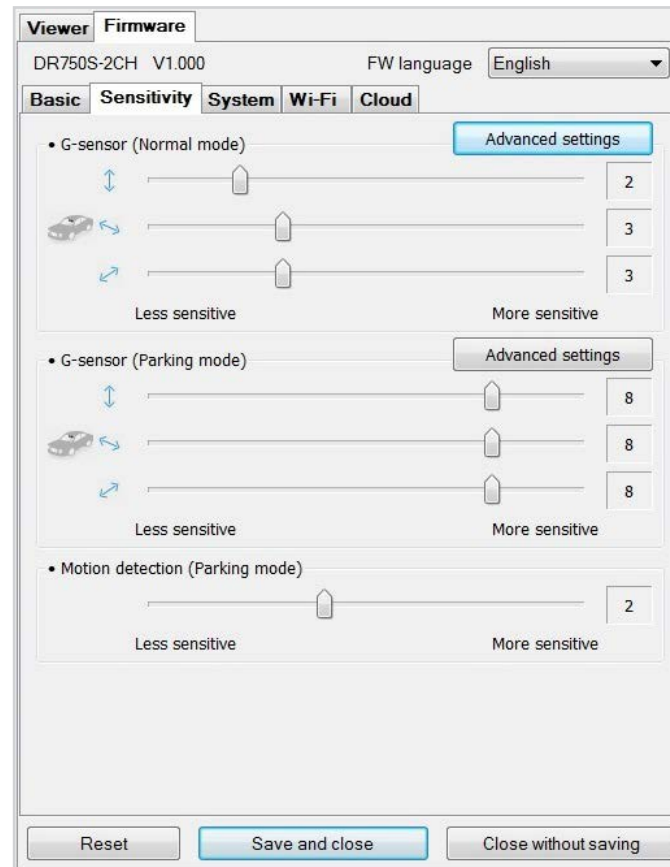

■ G-Sensor (Normal mode) / G-Sensor (Parking mode)

The G-sensor measures the movement of your vehicle through 3 axes – up and down, side to side, and front and back. When the G-sensor detects significant or sudden movement (such as an impact or collision) it will trigger an event recording. You can adjust the sensitivity so minor incidents and bumps don't trigger an event recording. To turn off event recordings by impact detection set the G-sensor sensitivity to off.

■ Motion detection (Parking mode)

In parking mode the dashcam continuously buffers video and saves a parking recording when motion is detected in the dashcam's field of view.

You can adjust the sensitivity of the motion detection so minor motion caused by wind or rain doesn't trigger a recording. Please take into account your vehicle's surroundings when adjusting the sensitivity.

■ Advanced sensitivity settings for normal and parking mode

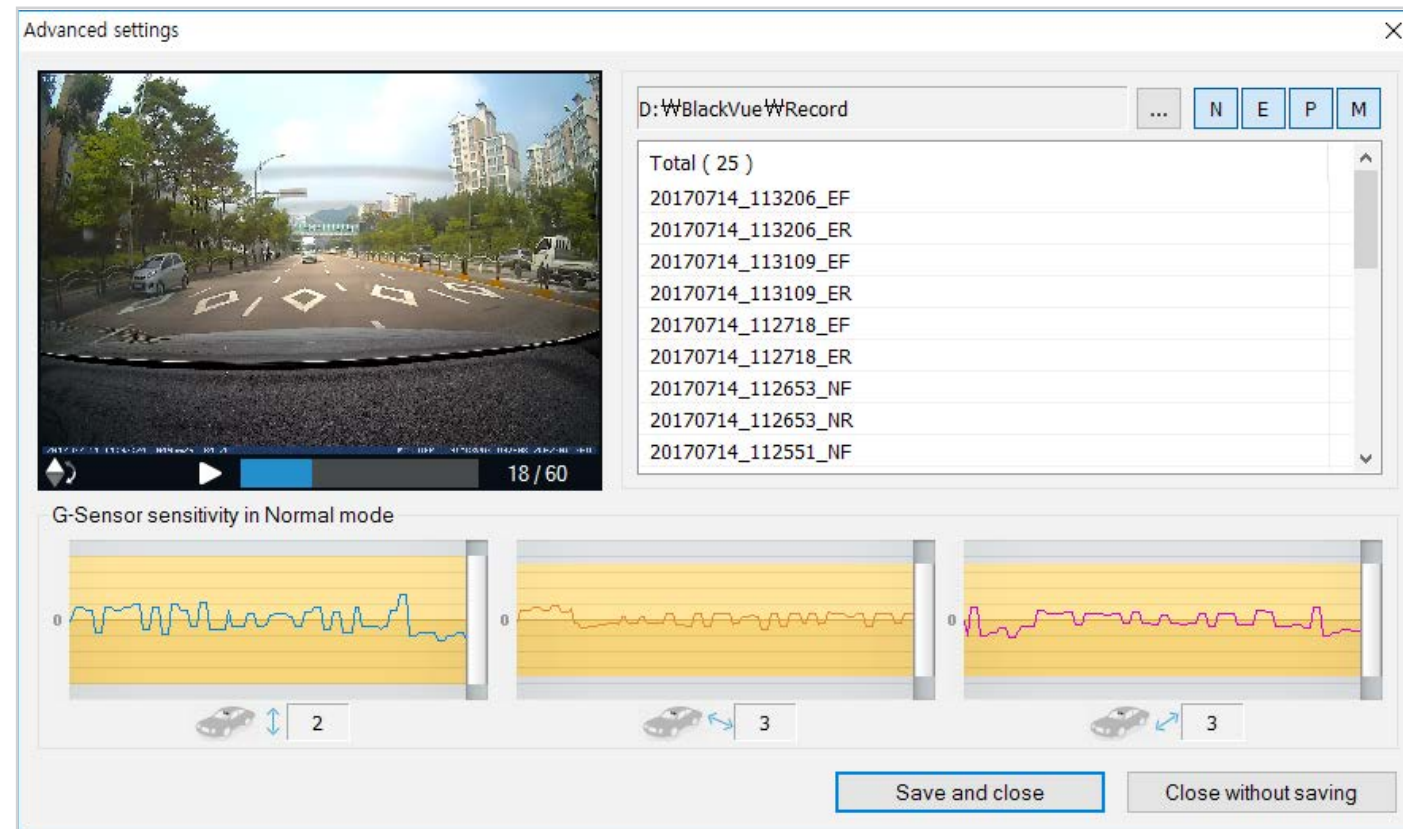

Advanced sensitivity settings allows you to fine-tune the event recording G-Sensor threshold, while watching pre-recorded G-Sensor data and video as a reference.

- 1 Click the **Advanced settings** button.
- 2 Double click the video from the list that you want to use as a G-Sensor data reference.
- 3 Set the thresholds by adjusting the control bars next to each G-Sensor axis. Any G-Sensor data that crosses over the threshold on any of the 3 axes will trigger an Event recording.

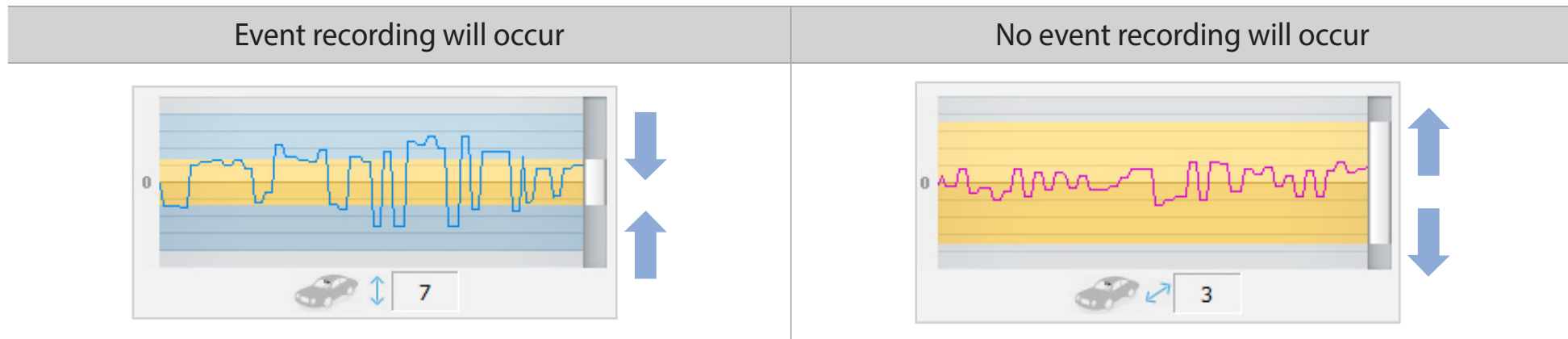

- 4 Click **Save and close**.

System settings

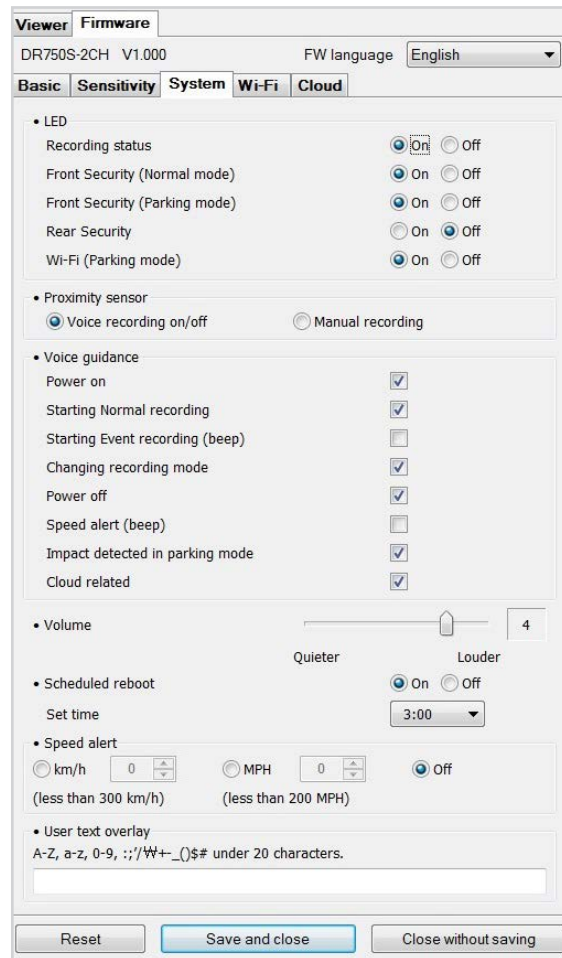

LED

– Recording status

You can turn the recording status LED on/off.

– Front security (Normal mode)

You can turn the front security LED on/off for normal mode.

– **Front security (Parking mode)**

You can turn the front security LED on/off for parking mode.

– **Rear security**

You can turn the rear security LED on/off.

– **Wi-Fi (Parking mode)**

You can turn the Wi-Fi LED on/off for parking mode.

■ **Proximity Sensor**

You can choose the function of proximity sensor. It can be configured either for audio recording on/off feature or to trigger manual recording.

■ **Voice guidance**

You can adjust the voice guidance (announcements) you want to hear.

■ **Volume**

You can adjust the volume of the voice guidance (announcements).

■ **Scheduled Reboot**

The dashcam reboots automatically once-a-day if in parking mode at the set time for improved stability. If the dashcam is recording at the set time, the scheduled reboot is skipped.

You can enable/disable and change the time for scheduled rebooting. Default time is 03:00 am.

■ **Speed alert**

Set a speed limit (up to 300 km/h or 200 MPH) for the speed alert. When the vehicle exceeds the specified speed limit, the dashcam beeps and switches to event recording. After saving one event recording file the dashcam switches back to normal mode recording.

■ **User text overlay**

You can create a user text overlay of up to 20 characters using a combination of English letters (A – Z, a – z), numbers (0 – 9), and symbols (;:/+_-)\$#). The text is overlaid in the top-left corner of the recorded videos.

Wi-Fi settings

The screenshot shows the 'Wi-Fi' settings page for a dashcam. At the top, it displays 'DR750S-2CH V1.000' and 'FW language English'. The 'Wi-Fi' tab is selected among 'Basic', 'Sensitivity', 'System', 'Wi-Fi', and 'Cloud'. Under 'Wi-Fi auto turn off', there are radio buttons for 'On' and 'Off', with 'Off' selected. Below this, it says 'Turn off after 10 minutes of inactivity'. The 'Login credentials' section has two input fields for 'SSID' and 'Password', and a 'Show password' checkbox. At the bottom, there are three buttons: 'Reset', 'Save and close' (highlighted in blue), and 'Close without saving'.

Login credentials

You can change the dashcam's SSID and Wi-Fi login password.

Wi-Fi auto turn off

When the Cloud service is enabled the Wi-Fi auto turn off setting cannot be adjusted. Wi-Fi will automatically switch on when you turn on the dashcam and remain on.

If you disable the Cloud service, you will be able to adjust the Wi-Fi auto turn off setting.

	ON	OFF
Wi-Fi auto turn off	Wi-Fi turns off if it is inactive for 10 minutes.	Wi-Fi does not turn off automatically.

Cloud settings

The screenshot shows the 'Cloud' settings page in the BlackVue firmware interface. At the top, it displays 'DR750S-2CH V1.000' and 'FW language English'. The 'Cloud' tab is selected, showing options to 'Enable Cloud service' (set to 'On'), 'Cloud service hotspot settings' (with three SSID/Password pairs), and 'Push notification settings' (with several checked options). A note at the bottom states: 'The BlackVue dashcam is not compatible with 5GHz wireless networks.' Buttons for 'Reset', 'Save and close', and 'Close without saving' are at the bottom.

Viewer Firmware
DR750S-2CH V1.000 FW language English

Basic Sensitivity System Wi-Fi Cloud

- Enable Cloud service On Off
- Cloud service hotspot settings
 - 1 SSID: Password:
 - 2 SSID: Password:
 - 3 SSID: Password:
- Show password
- Wi-Fi authentication (WPA2PSK)
- The BlackVue dashcam is not compatible with 5GHz wireless networks.
- Push notification settings
 - Manual recording
 - Motion detection (Parking mode)
 - Event recording (Parking mode)
 - Event recording (Normal mode)
 - Overspeed (Normal mode)
 - Enter/exit parking mode

Reset Save and close Close without saving

Enable Cloud service

If you don't use the Cloud service you can turn it off.

■ Cloud service hotspot settings

Up to 3 Wi-Fi hotspot SSIDs can be saved (e.g. home, portable hotspot and work). Choose your Wi-Fi hotspot from the list and enter the password. Tap 2 and 3 to add settings for additional hotspots.

Your BlackVue will try to connect to hotspot 1 first. If it cannot connect to hotspot 1, it will then try to connect to hotspot 2, and then hotspot 3.



Note

- The DR750S-1CH, DR750S-2CH dashcam is not compatible with 5GHz wireless networks.

■ Push notification settings

You can customize when you want to receive push notifications.

□ Applying the settings

You can automatically apply the configuration by inserting the microSD card into the BlackVue dashcam and turning it on. Configure the settings before using the dashcam.

To reset all settings to their defaults press the **Reset** button at the bottom of the settings panel.

About the Cloud Service

Using a mobile Wi-Fi hotspot or a car-embedded wireless internet connection you can connect your dashcam to the internet and take advantage of the following features in the BlackVue app and BlackVue Cloud Viewer:

Live View – Watch your dashcam's live video feed.

Push notifications – Be notified on your smartphone when something happens to your car.

GPS tracking – See in real-time where your car is and track your car's route and speed.

Two-way voice communication – Initiate voice chat from your smartphone to your dashcam.

Video backup – Backup video recordings to the Cloud or your smartphone's storage.

Video playback – Watch recorded videos stored on your dashcam or in the Cloud on your smartphone anywhere, anytime.

Connect to BLACKVUE CLOUD (Optional)

If you don't have a mobile Wi-Fi hotspot, or if you don't want to use the BLACKVUE CLOUD service, you can skip this step.

If you have a mobile Wi-Fi hotspot (also known as a portable Wi-Fi router), a car-embedded wireless internet network or a Wi-Fi network near your car, you can use the BlackVue app to connect to BLACKVUE CLOUD and see in real-time where your car is and the dashcam's live video feed.

For more information about using the BlackVue app, please download the BlackVue app Manual from www.blackvue.com > **Support** > **Downloads**.

1 Create an account

- (i) Open the BlackVue app.
- (ii) Tap the  button in the top-left corner and select **Create account**.
- (iii) Enter your email address and choose a password. Re-enter your password and press **Next**.
- (iv) After reading the Terms & Policies, check the boxes and press the **Create account** button to continue.
- (v) You will receive an e-mail. Click the link in the email to finish creating your account.

2 Register your dashcam with your account

- (i) In the BlackVue app select **BLACKVUE CLOUD** and login to your account.
- (ii) Tap **Yes** to enable push notifications (this setting can be adjusted at any time later).
- (iii) Select **Register new camera**.
- (iv) Register your camera using one of the following methods:

QR Code: Press **Scan QR Code** and line up the QR Code on your smartphone's screen.

*The QR code can be found labeled on the front camera when you remove it from its mount.

or

Manual registration: Enter your camera's Serial number and Cloud code and press **Register**.

- (v) The app will ask for your permission to access your dashcam's GPS data. If you **allow** access the app will be able to show you your dashcam's location and speed. If you **don't allow** access you won't be able to see your dashcam's location and speed (you can allow access later in Privacy settings).

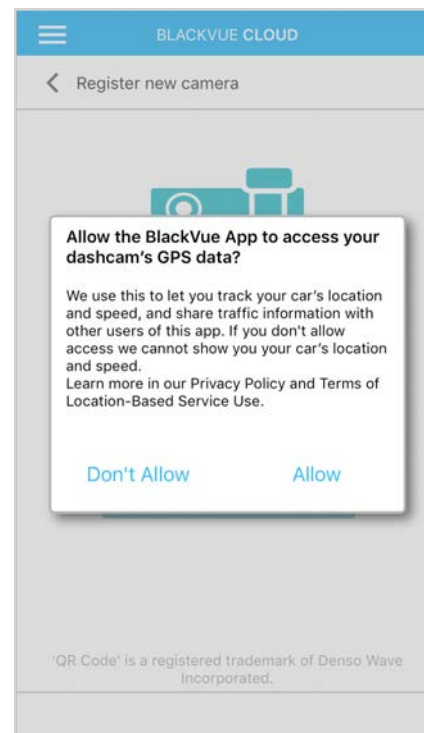

3 Connect your BlackVue dashcam to a Wi-Fi hotspot for Cloud connectivity

Click here for a step-by-step video tutorial, or go to the main menu and select **Help > Video tutorials**.

- (i) Make sure your BlackVue dashcam and mobile Wi-Fi hotspot are on.
- (ii) "Pair" your smartphone with the BlackVue dashcam via direct Wi-Fi.
- (iii) Open the BlackVue app. Select **BLACKVUE WI-FI** >  > **Cloud settings**.



- (iv) Ensure **Enable Cloud service** is on. Select **Cloud service hotspot settings**.

(v) Choose your Wi-Fi hotspot from the list and enter the password. Tap 2 and 3 to add settings for additional hotspots. Once done, tap **OK**.

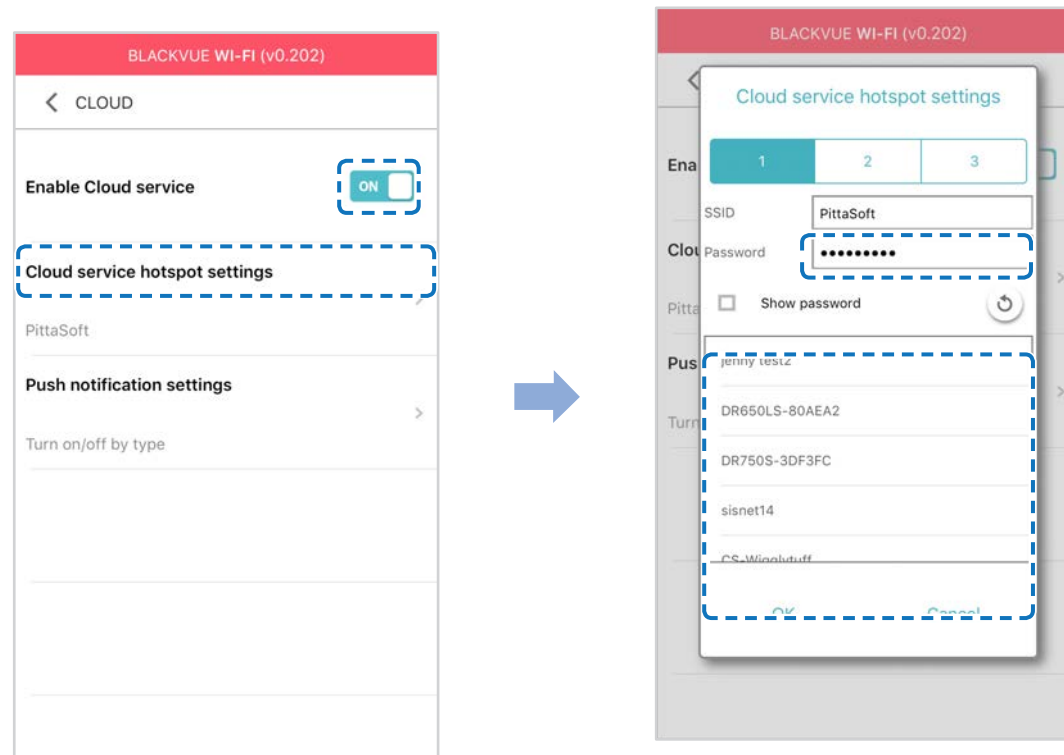

 **Note**

- Up to 3 Wi-Fi hotspot SSIDs can be saved (e.g. home, portable hotspot and work).
- The DR750S-1CH, DR750S-2CH dashcam is not compatible with 5GHz wireless networks.

(vi) Go back to the Firmware settings menu, tap  and tap **Save and close**.

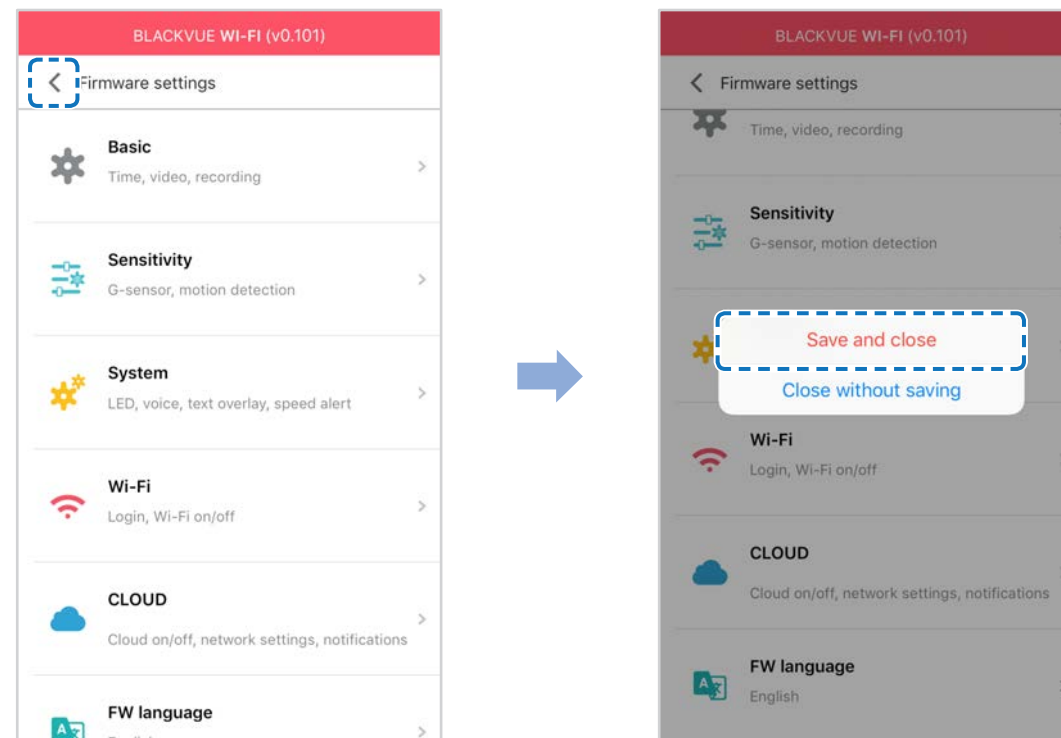

After rebooting, your dashcam will automatically connect to the Wi-Fi hotspot.

Select BLACKVUE CLOUD from the main screen to access all of the Cloud features.

Note

- You can also change the dashcam settings through BLACKVUE CLOUD by going tapping next to your camera name and select **Camera settings**.
- For more information about using the BlackVue app, please refer to the manual by going to the main menu and selecting **Help** > **App manual**.

▶ Parking mode hardwiring kit (Optional)

The BlackVue dashcam will turn off when the engine is turned off. To record video while the engine is turned off, a hardwiring kit (such as the Power Magic Pro) is required. The Power Magic Pro powers your dashcam when the engine is off by hardwiring it to the automotive battery. A low voltage power cut-off function and a parking mode timer protect your vehicle's battery from discharge.

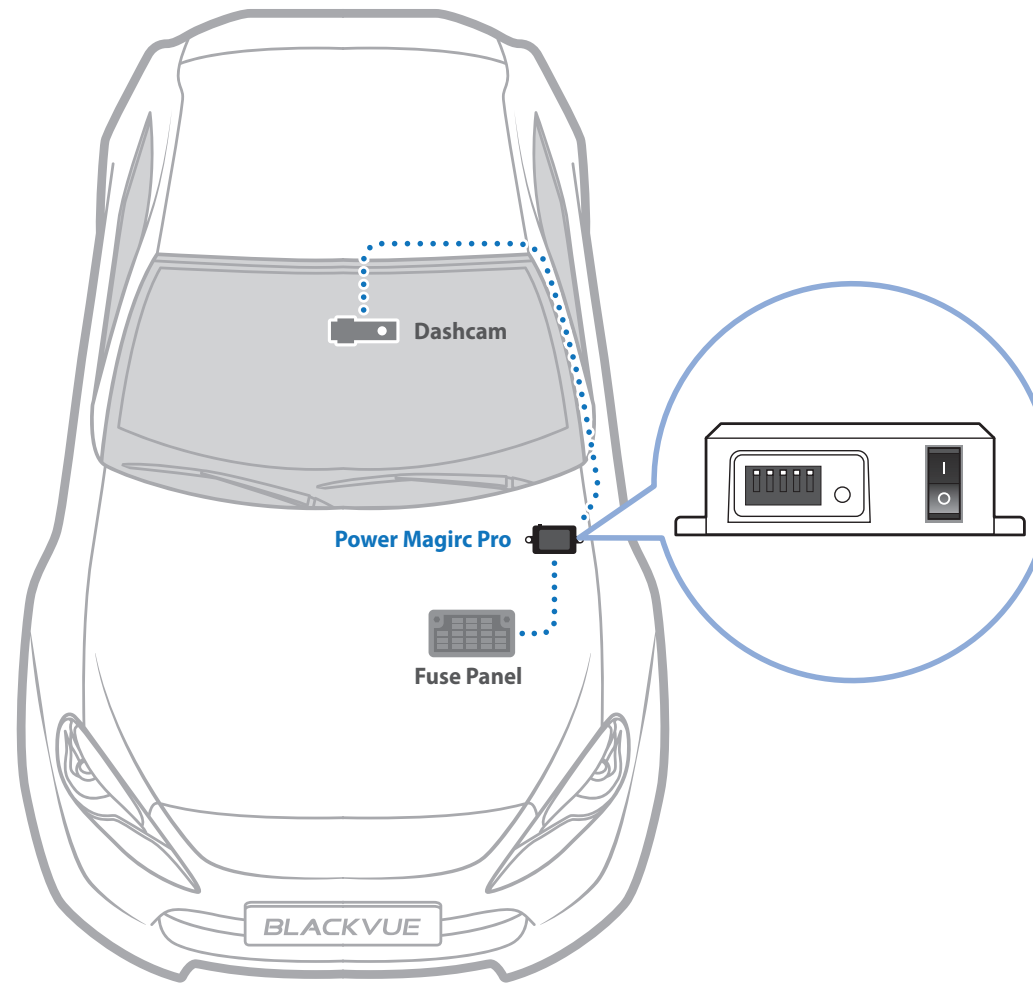

▶ Parking mode battery pack (Optional)

To record video when the engine is turned off without using the vehicle's battery, you can install a parking mode battery pack. The Power Magic Battery Pack B-112 powers a single dashcam for up to 12 hours after 1 hour of rapid charging. When the engine is off the battery pack powers the dashcam. When the engine is on the dashcam is powered directly from the vehicle's battery and the battery pack charges.

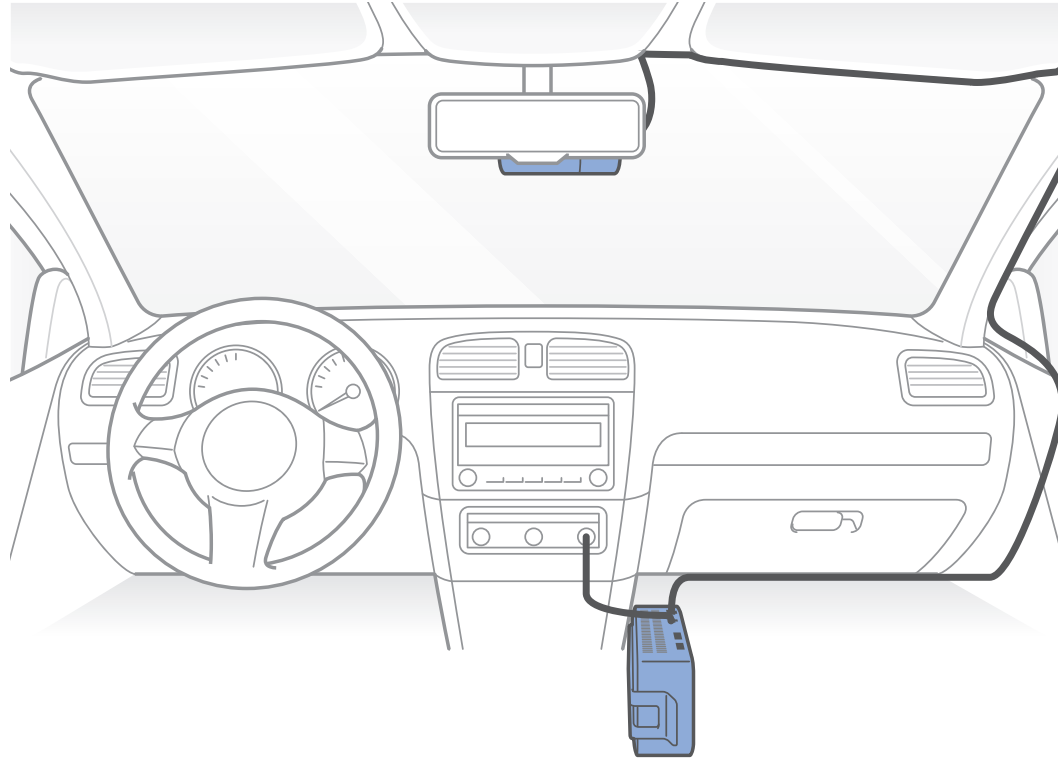

Changing / resetting direct Wi-Fi SSID and password

The dashcam's Wi-Fi SSID and password can be changed/reset using one of the following methods.

On-device Wi-Fi SSID and password reset

Press and hold the Wi-Fi button on the dashcam, for 5 seconds and once voice instructions start, release the button. Then press once again to reset the Wi-Fi SSID and password to default.

*The default Wi-Fi SSID and password can be found labeled on the front camera when you remove it from its mount.

➤ Change Wi-Fi SSID and password over the Cloud

1 Login to the BlackVue app.

2 Select **BLACKVUE CLOUD**.

Note

- You can access FW settings Over the Cloud only when the dashcam is ON and connected to the internet (Cloud). A blue colored icon means the dashcam is connected to the Cloud while a grey colored icon means that the dashcam is not connected to the Cloud.

3 Tap  next to your camera name and select **Camera settings** > **Firmware settings** > **Wi-Fi** > **Login credentials**.

You can change the camera's SSID and Wi-Fi login password.

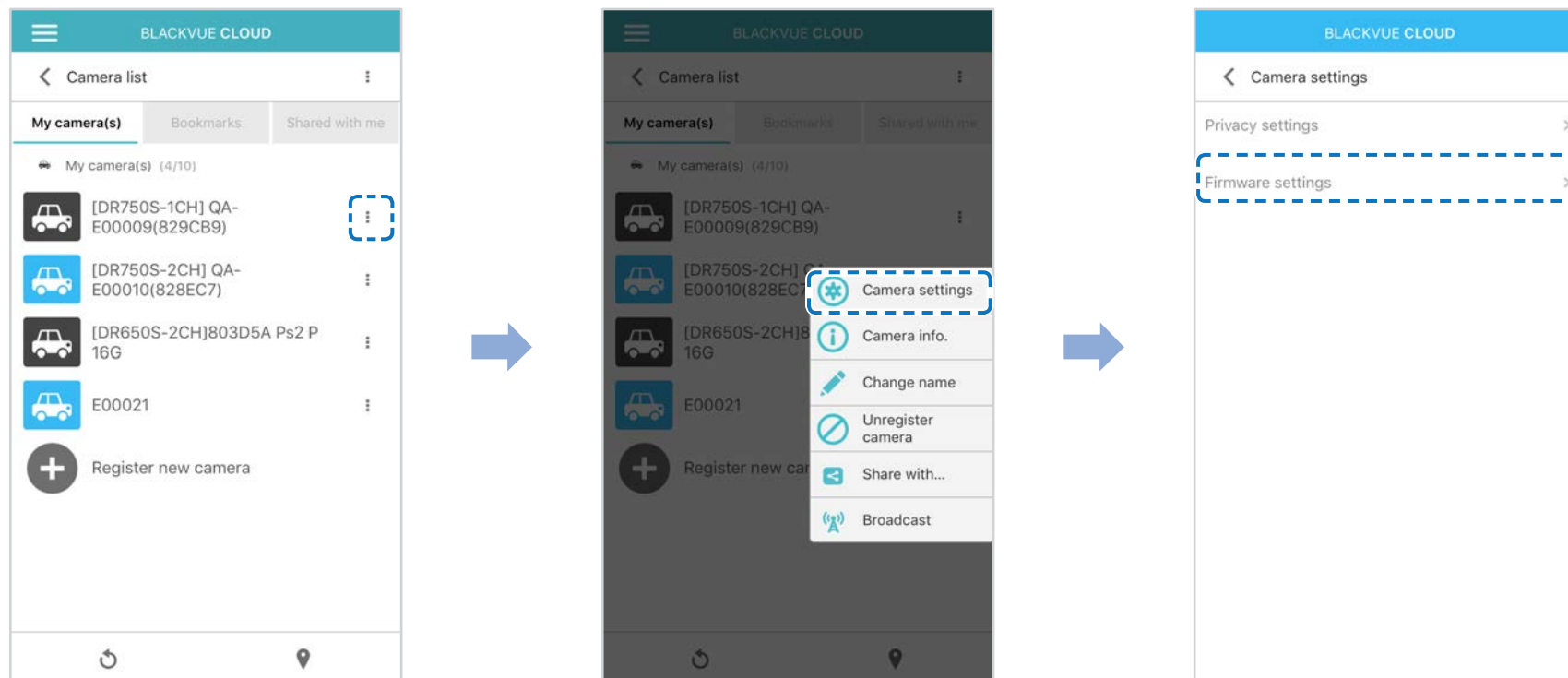

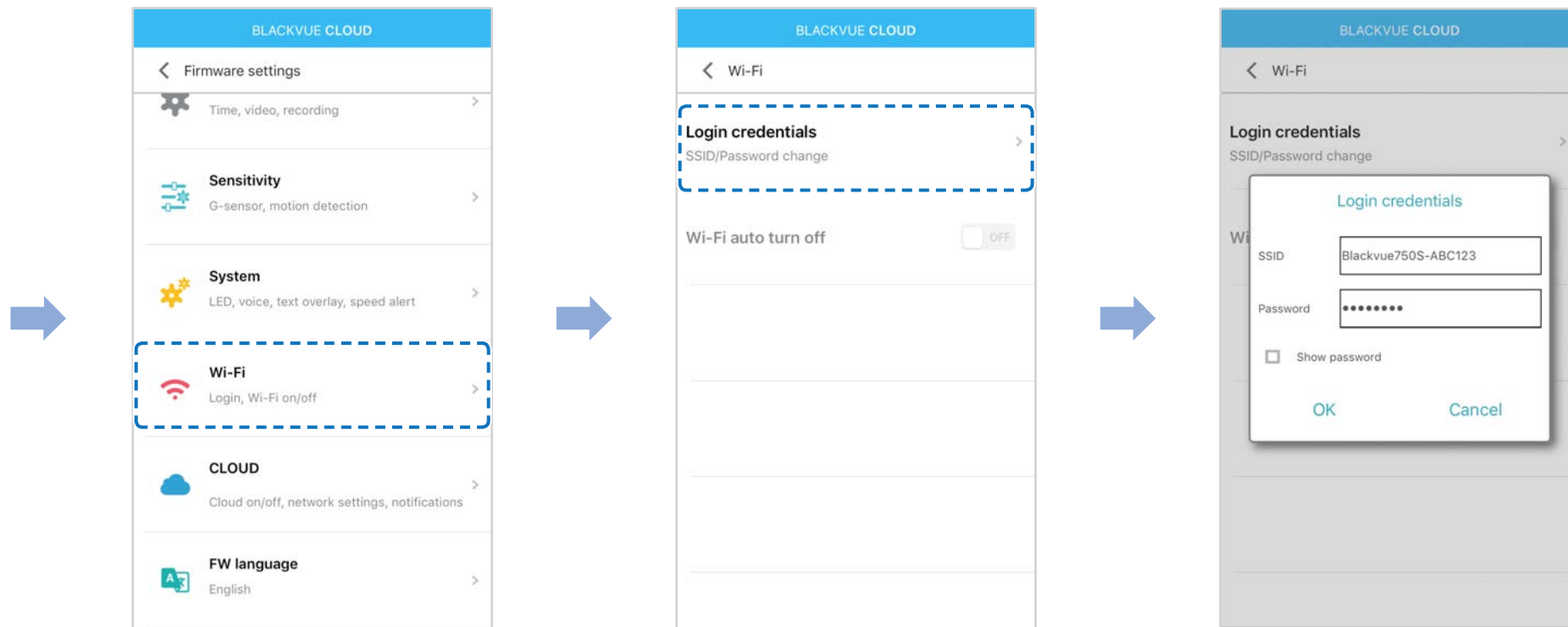

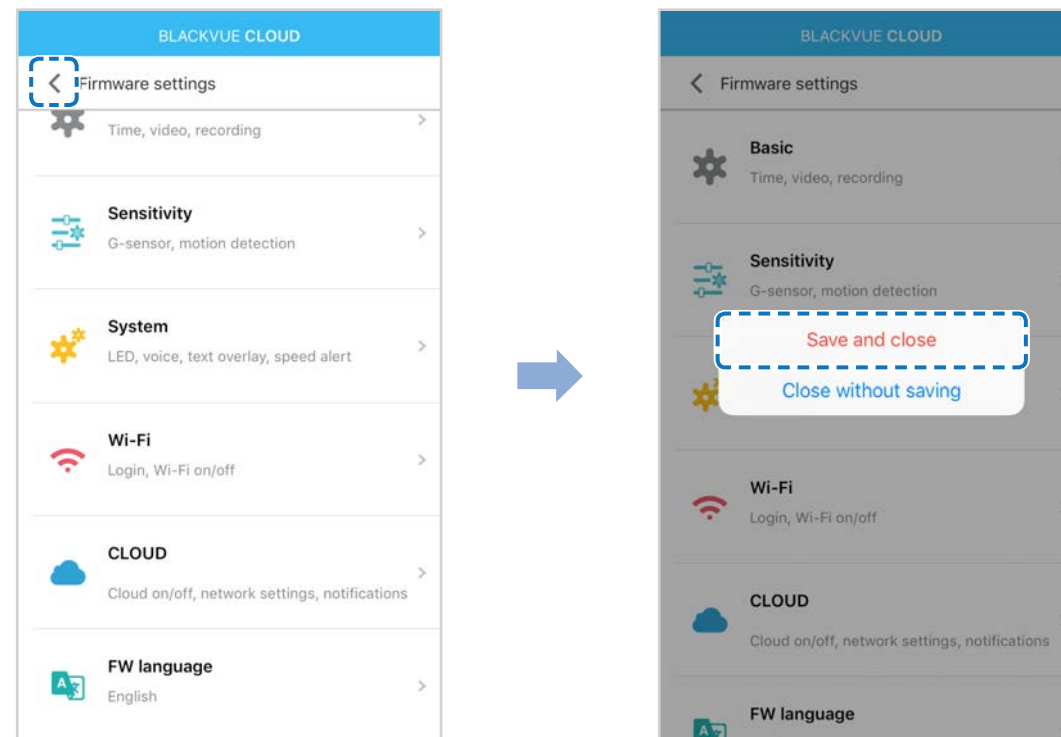

4 Go back to the Firmware settings menu, tap  and tap **Save and close**.



Change the Wi-Fi password using BlackVue Viewer (Windows or Mac)

- 1 Remove the microSD card from the dashcam.
- 2 Insert the card into the microSD card reader and connect it to a computer.
- 3 Launch BlackVue viewer.
*You can download **BlackVue Viewer** from www.blackvue.com > **Support** > **Downloads** and install it on your computer.
- 4 In BlackVue Viewer click on the  **Settings** button (Windows) or the  **BlackVue Viewer** menu (macOS) to open the BlackVue settings panel.
- 5 Click the **Firmware** tab, then the **Wi-Fi** tab and under **Login credentials** change the password.
- 6 Click **Save and close**.

Product specifications

Model Name	DR750S-2CH
Color/Size/Weight	Front: Black / Width 118.5 mm x Height 36 mm / 90 g Rear: Black / Width 67.4 mm x Height 25 mm / 25 g
Memory	microSD Card (16 GB / 32 GB / 64 GB/ 128 GB)
Recording Modes	Normal recording, Event recording (when impact is detected in normal and parking mode), Manual recording and Parking recording (when motion is detected) * For Parking mode recording, a Parking Mode Battery Pack (Power Magic Battery Pack) or a Parking Mode Hardwiring Kit (Power Magic Pro) is required.
Camera	Front: STARVIS™ CMOS Sensor (Approx. 2.1 M Pixel) Rear: STARVIS™ CMOS Sensor (Approx. 2.1 M Pixel)
Viewing Angle	Front: Diagonal 139°, Horizontal 116°, Vertical 61° Rear: Diagonal 139°, Horizontal 116°, Vertical 61°
Resolution/Frame Rate	<Front - Rear> Full HD (1920x1080) @60fps - Full HD (1920x1080) @30fps (Sports) Full HD (1920x1080) @30fps - Full HD (1920x1080) @30fps Full HD (1920x1080) @30fps - HD (1280x720) @30fps HD (1280x720) @30fps - HD (1280x720) @30fps *Frame rate may vary during Wi-Fi streaming.
Image Quality	Highest, High, Normal
Video Compression Mode	MP4
Wi-Fi	Built-in (802.11n (2.4 – 2.4835 GHz))
GPS	Built-in
Microphone	Built-in
Speaker (Voice Guidance)	Built-in
LED Indicators	Front: Recording LED, GPS LED, Wi-Fi LED, Front Security LED Rear: Rear Security LED

Button	<p>Wi-Fi / Format button: Press once to turn on/off Wi-Fi. Press and hold for 5 seconds and once voice commands start, release the button. Then press once again to reset the Wi-Fi SSID and password or press and hold for 5 seconds to format the microSD card.</p> <p>Proximity sensor: Touching the proximity sensor turns on/off audio recording or triggers manual recording depending on the firmware settings.</p>
Sensor	3-Axis Acceleration Sensor
Backup Battery	Built-in super capacitor
Input Power	DC 12 V - 24 V (DC Plug:  (Ø3.5 x Ø1.35), MAX 1 A/12 V)
Power Consumption	<p>Avg. 350 mA (4.2 W at 12 V, when GPS and Wi-Fi is On) Avg. 300 mA (3.6 W at 12 V, when GPS and Wi-Fi is Off) Actual power consumption may vary depending on use conditions and environment.</p>
Operation Temperature	-20 °C – 70 °C (-4 °F – 158 °F)
Storage Temperature	-20 °C – 70 °C (-4 °F – 158 °F)
High Temperature Cut-Off	Approx. 80 °C (176 °F)
Certifications	<p>Front: FCC, CE, RoHS, Telec, WEEE Rear: FCC, CE, RoHS, WEEE</p>
Software	<p>BlackVue Viewer Windows XP or higher and Mac Yosemite OS X (10.10) or higher</p>
Application	BlackVue Application (Android 4.4.2 or higher, iOS 9.0 or higher)
Others	Adaptive Format Free File Management System

* STARVIS is a trademark of Sony Corporation.

Recording time

Your dashcam will automatically turn on and start recording when it is connected to a power source.

Memory Capacity		Resolution	FHD @ 60 + FHD @ 30	FHD @ 30 + FHD @ 30	FHD @ 30 + HD @ 30	HD @ 30 + HD @ 30
16GB		Highest	1 HR 25 MIN	1 HR 25 MIN	1 HR 35 MIN	2 HR
		High	x	1 HR 50 MIN	2 HR	2 HR 40 MIN
		Normal	x	2 HR 20 MIN	2 HR 40 MIN	4 HR
32GB		Highest	2 HR 50 MIN	2 HR 50 MIN	3 HR 10 MIN	4 HR
		High	x	3 HR 40 MIN	4 HR	5 HR 20 MIN
		Normal	x	4 HR 40 MIN	5 HR 20 MIN	8 HR
64GB		Highest	5 HR 40 MIN	5 HR 40 MIN	6 HR 20 MIN	8 HR
		High	x	7 HR 20 MIN	8 HR	10 HR 40 MIN
		Normal	x	9 HR 20 MIN	10 HR 40 MIN	16 HR
128GB		Highest	11 HR 20 MIN	11 HR 20 MIN	12 HR 40 MIN	16 HR
		High	x	15 HR 40 MIN	16 HR	21 HR 20 MIN
		Normal	x	18 HR 40 MIN	21 HR 20 MIN	32 HR
Bitrate	Front	Highest	12 Mbps	12 Mbps	12 Mbps	8 Mbps
		High	x	10 Mbps	10 Mbps	6 Mbps
		Normal	x	8 Mbps	8 Mbps	4 Mbps
	Rear	Highest	10 Mbps	10 Mbps	8 Mbps	8 Mbps
		High	x	8 Mbps	6 Mbps	6 Mbps
		Normal	x	6 Mbps	4 Mbps	4 Mbps

Note

- If the microSD card is full, older files are deleted first to make space for newly-recorded videos.
- Total recording time is different depending on the memory capacity of the microSD card and the resolution of the video.

Disposal of your BlackVue dashcam



1. All electrical and electronic products should be disposed of separately from the municipal waste stream via designated collection facilities appointed by the government or the local authorities. Contact local authorities to learn about disposal and recycling options available in your area.
2. The correct disposal of your BlackVue dashcam will help prevent potential negative consequences for the environment and human health.
3. For more detailed information about disposal of your BlackVue dashcam, please contact your city office, waste disposal service or the shop where you purchased the product.

Customer Support

For customer support and firmware updates please visit www.blackvue.com

You can also email a Customer Support expert at cs@pittasoft.com

Before Requesting Service

Please back up all important files and data before requesting service. In order to service the dashcam it may be necessary to delete all files and data from the dashcam. All servicing is provided on the basis that the user has backed up all necessary files and data before requesting service. Therefore Pittasoft Co., Ltd. will not be responsible for the loss of any files or data.

Copyright & Trademark

- This instruction manual is protected by Copyright Law, and all rights to it are protected by law.
- It is prohibited to reproduce, copy, modify, or translate this instruction manual without permission.

 **BLACKVUE** BlackVue is the registered trademark of Pittasoft Co., Ltd. Pittasoft Co., Ltd. reserves all rights regarding all works related to the BlackVue brand such as product design, trademarks, and product-promotional videos. It is prohibited to reproduce, copy, modify, or use related works without permission. Any violation may be penalized in accordance with the relevant regulations.



YCK-DR750S-2CH

Product | Car Dashcam

Model Name | DR750S-2CH

Manufacturer | Pittasoft Co., Ltd. / South Korea

Address | 7F, BYC HIGHCITY Building A 131, Gasan Digital 1-ro, Geumcheon-gu, Seoul, Republic of Korea, 08506

Customer Support | cs@pittasoft.com

Product Warranty | One-Year Limited Warranty

 facebook.com/BlackVueOfficial

www.blackvue.com

Made in Korea